

M

LEDME

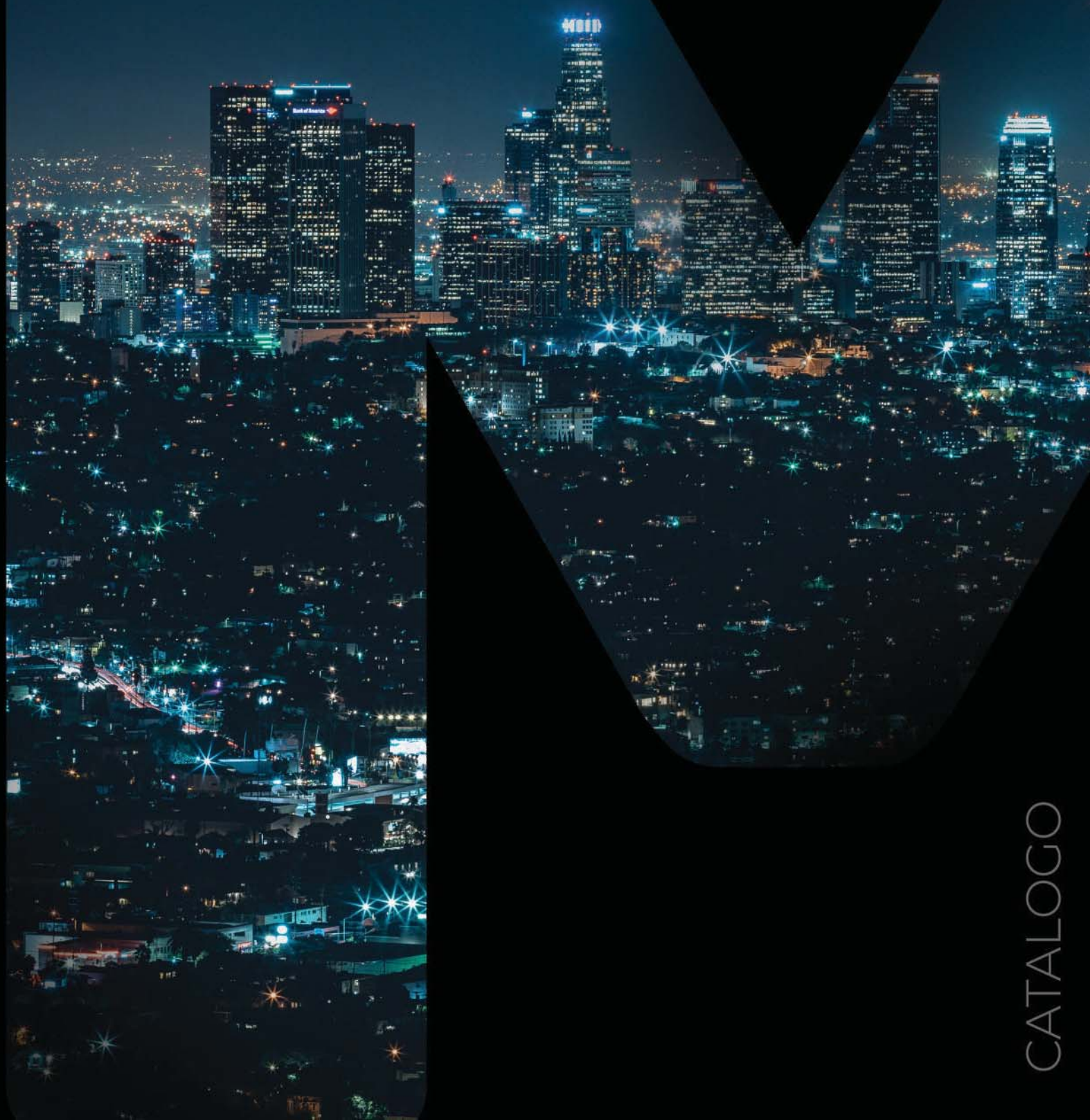

CATALOGO

2. SMARTHOME



3. Lámpara de pie Coright CCT



3. Bombilla LED SmartHome G45 6W



3. Bombilla LED SmartHome C37 6W



3. Bombilla LED SmartHome E27 A60 10W



4. Bombilla LED SmartHome GU10 5W



5. Downlight LED SmartHome Nail 9W



5. Plafón LED SmartHome Dial 24W



5. Plafón LED SmartHome RainBow Wifi App CCT



5. Panel LED SmartHome RGB+CCT



7. Foco Proyector LED SmartHome



8. Enchufe Wifi SmartHome 16A



8. Controlador Mini Para Tiras LED RGB Control remoto por IR / APP Magic Home



8. Controlador Wifi Rgb+Cct



8. Fuente de Alimentación Dimable Por APP Tuya LED 24V dc RGB+CCT

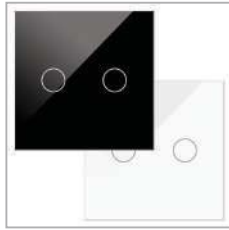

9. Interruptor Táctil Con Wifi



11. Robot Aspirador SmartHome Mimotec 2300 Pa

14. INTERIOR



15. Bombilla LED Colours Gu10 5W Rgbw Con Mando



15. Bombilla LED Colours A60 E27 10W Rgbw Con Mando



15. Bombilla LED E27



16. Bombilla LED E14



16. Bombilla LED E14 R50



16. Bombilla LED E27 R80



16. Driver PHILIPS Certadrive 220-240V 1050mA



17. Bombilla LED E27 Serie T



17. Bombilla LED E27 Industrial Iris



17. Bombilla LED E27 G125



17. Bombilla LED AR111



18. Bombilla LED GU10 Smd Plus



18. Bombilla LED Mr16 Smd Plus



18. Bombilla LED G45 E14



19. Bombilla LED E27 Antimosquitos



20. Bombilla LED Filamento E27 Ámbar



20. Bombilla LED Filamento E14 G45 Ámbar



20. Bombilla LED Filamento E14 Ámbar



20. Bombilla LED Filamento E14 Punta Ámbar



21. Bombilla LED Filamento E27 ST64 Ámbar



21. Bombilla LED Filamento Espiral E27 ST64 Ámbar



21. Bombilla LED Filamento Espiral E27 Ámbar



21. Bombilla LED Filamento Espiral E27 A160 Ámbar



22. Bombilla LED Filamento Espiral E27 Botella 62 mm Ámbar



22. Bombilla LED Filamento Espiral E27 Botella 70 mm Ámbar



22. Bombilla LED Filamento Espiral E27 BT180 Ámbar



22. Bombilla LED Filamento Espiral E27 A165 4W Ámbar



23. Bombilla LED Filamento Espiral E27 G125 Ball Ámbar



23. Bombilla LED E27 PAR30



23. Bombilla LED E14 Mini



23. Bombilla LED R7S 118 10W



24. Downlight LED Deep Cct



24. Downlight LED Didle



24. Downlight LED Road



25. Downlight LED Cobfix



25. Downlight LED Cobmon



25. Panel LED Circular Serie Pro



26. Panel LED Circular Serie Slim



26. Panel LED Cuadrado Serie Slim



27. Panel LED Circular Níquel CCT



27. Panel LED Circular Níquel CCT



27. Panel de Superficie Serie Slim



28. Panel de Superficie Serie Pro Circular



28. Panel de Superficie Serie Slim Cuadrado



28. Panel de Superficie Níquel Circular CCT



29. Panel de Superficie Níquel Cuadrado CCT



29. Downlight LED Lass 22W



29. Downlight LED Lass 32W

INDICE



29. Downlight LED Lass 50W



30. Plafon LED Circular Sense



31. Downlight LED Luxtar



31. Plafón LED Halls con Sensor Movimiento



32. Plafón Sensor Movimiento Nantes



32. Plafón Sensor Movimiento Turin



33. Plafon LED Circular Bari CCT



33. Plafon LED Circular Serie Trielle Remo CCT



33. Plafon LED Circular Dial



33. Plafon LED Circular Ice



34. Plafón LED Magic Serie Bure Rgb+CCT



35. Panel LED Serie Trielle 60W



35. Panel LED Serie Trielle 42W



35. Panel LED Serie Trielle UGR17



35. Panel LED Rectangular Serie Bure 24W



36. Panel LED Rectangular Serie Bure 40W

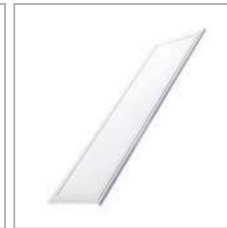

36. Panel LED Rectangular Serie Bure



36. Panel LED de Superficie Rectangular Serie Home

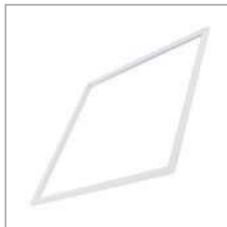

36. Panel LED de Marco Luminoso



37. Kit de superficie de Panel Blanco



37. Marco de empotrar de Panel LED



37. Tubo LED T8 Stak Cristal Conexión Un Lateral



37. Tubo de LED T8 Ekran



38. Tubo de LED T8 Conexión Un Lateral



38. Tubo de LED T8 Ekran Con detector de Movimiento il.Seguridad



39. Soporte para tubo LED Zaslon Conexión un lado



39. Pantalla Estanca Platno para dos tubo LED



39. Regleta LED SlimLine Fast



39. Regleta LED Slimline Moments



40. Barra Lineal Trian



40. Regleta LED SlimLine Garaz



41. Barra lineal Barcelona 40W



42. Emergencia LED Zovy Autotest



43. Módulo LED ArumLED 7W



43. Aro para modulo ArumLED / GU10 / MR16 - Manu



44. Aro para modulo ArumLED / GU10 / MR16 - Loau



44. Aro para modulo ArumLED / GU10 / MR16 - Maka



45. Aro para modulo ArumLED / GU10 / MR16 - Maika



45. Aro para modulo ArumLED / GU10 / MR16 - Lani



46. Aro para modulo ArumLED / GU10 / MR16 - Makaili



46. Aro para modulo ArumLED / GU10 / MR16 - Hopaka



47. Aro para modulo ArumLED / GU10 / MR16 - Miata



48. Baliza LED Nomis Square Empotrable



48. Baliza LED Nomis Square Empotrable con Sensor PIR

50. EXTERIOR



51. Aplique LED Sphere Sensor Movimiento



51. Plafón LED Oval Screw



51. Plafón LED Screw 20W IP65



51. Plafón LED Sphere Con Sensor Movimiento



52. Aplique Led Cinza



52. Aplique Led Dynamic



52. Aplique de pared LED Tube



52. Aplique de Pared LED Cube 6W



54. Baliza Cam



54. Baliza Double Urban



54. Baliza Urban



54. Baliza Design Plus



56. Aplique Urban



56. Aplique Cam



56. Aplique de pared Tube



56. Aplique Design



58. Baliza LED Enfine Empotrable



58. Baliza LED Line Empotrable

INDICE



58. Baliza LED Desan Empotrable



58. Baliza LED Circle Empotrable



59. Baliza LED Biral de Superficie



59. Foco empotrable GubBet Para suelo GU10



59. Regulador Led 0-10V



59. Aplique Led Jano Solar



60. Aplique Led Jano Cory



60. Baliza Led Solar Buy De suelo con pincho



60. Aplique LED Solar Mustang con Sensor Movimiento



60. Aplique LED Solar Venus con Sensor Movimiento



61. Aplique LED Solar Natur con Sensor Movimiento



61. Aplique LED Solar Mus con Sensor Movimiento



61. Aplique LED Solar Moon con Sensor Movimiento



61. Aplique LED Solar Sun con Sensor Movimiento



62. Aplique LED Solar Star



62. Foco Proyector Led Solar Venecia



63. Solar LED SphereGlass Vintage exterior



63. Proyector Solar LED Portátil Con Batería Power Bank

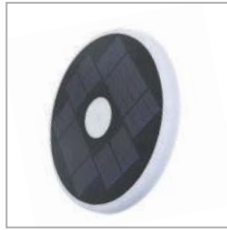

64. Foco LED Must Para Piscina Solar



65. Foco proyector LED Portátil con Batería Laptop



65. Foco Proyector Led Napoli



65. Foco proyector LED SMD



66. Foco Proyector Led Infinity



67. Foco Proyector Led Slim Series



68. Foco Proyector Led Napoli



68. Foco Proyector SMD Pro



69. Foco Proyector Led Napoli Con Sensor de movimiento



70. Foco Proyector Led Planet



72. Wall Washer Foss



73. Foco Modular Led Coliseo



74. Foco Modular LED Coliseum



75. Foco Modular LED Stadium



76. Foco Modular LED Premium



77. Driver Meanwell XLG Para Foco Modular LED Speed / Heatsing

78. COMERCIAL



79. Cadena de 20 Módulos de 1 LED SMD 3030 Osram



79. Cadena de 20 Módulos de 3 LED SMD 5730



79. Cadena de 20 Módulos de 3 LED SMD 2835



79. Cadena de 20 Módulos de 1 LED SMD 3030



80. Cadena de 20 Módulos de 1 LED Cob



80. Cadena de 20 Módulos de 3 LEDsMD 5730



80. Foco LED 30W Para Carril Clean Monofásico



80. Foco LED Prolux Para Carril Monofásico 40W



81. Foco Led Fast 30W Para Carril Monofásico



81. Foco LED Berna 12W Para Carril Monofásico



81. Foco Para Carril GU10 City



81. Foco GU10 Para Carril State



82. Foco Led Para Carril Aras 30W Monofásico CCT



82. Foco Led Para Carril Promax 40W Monofásico



83. Foco portalámparas E27 Para Carril Movie Monofásico



83. Foco portalámparas GU10 Para Carril Movie Monofásico



84. Conector en L Para Carril Monofásico



84. Conector en T Para Carril Monofásico



84. Conector I Reforzado Para Carril Trifásico



84. Base empotrable con carril Blanco Monofásico



85. Base de Superficie con carril Blanco Monofásico



85. Carril Monofásico Reforzado



85. Foco Led Turin Para Carril Trifásico



87. Foco LED Lepsie Para carril Trifásico No Flicker



87. Foco LED Milan 30W Para Carril Trifásico



87. Base Promax Negro Para Carril Trifásico



87. Conector Flexible Para Carril Trifásico



88. Conector y Tapón Para Carril Trifásico



88. Conector Tipo X Para Carril Trifásico



88. Conector en línea Para Carril Trifásico

INDICE



88. Conector con separador en línea Para Carril Trifásico



89. Conector tipo L Para Carril Trifásico



89. Conector tipo T Para Carril Trifásico



89. Carril Trifásico 2 metros



90. Foco LED Detail Plus Para Carril Magnético Negro 48V



90. Foco LED Hallway Detail Para carril magnético 48V



90. Foco LED Lounge Detail Para carril magnético 48V



91. Foco LED Linéaire Detail Para carril Magnético 48V



91. Foco LED Detail Para carril Magnético 48V



91. Conexión con cable de inicio Para Carril Magnético



92. Driver 48V Para Carril Magnético Detail



92. Conexión doble Para Carril Magnético



92. Unión en L Horizontal Para Carril Magnético Detail



92. Unión en T Horizontal Para Carril Magnético Detail



93. Unión en L Vertical Para Carril Magnético Detail



93. Unión en X Horizontal Para Carril Magnético Detail



96. Carril Magnético de empotrar Detail



96. Carril Magnético Detail



96. Lámpara lineal LED Viena 40W (UGR 17)



96. Lámpara lineal LED Vision 30W



97. Lámpara lineal LED Viena II 40W (UGR 19)



98. Módulo Led Cobfix 10W



99. Aro Empotrable Para Módulo Cobfix 10W



99. Aro de Superficie Para Módulo Cobfix 10W



99. Aro de Superficie 2L Para Módulo Cobfix 10W



99. Aro de Superficie 3L Para Módulo Cobfix 10W



100. Aro de Superficie 4L Para Módulo Cobfix 10W



100. Aro Empotrable para módulo Cobfix 10W



100. Aro Empotrable 2L para módulo Cobfix 10W



100. Aro Empotrable 3L para módulo Cobfix 10W



101. Panel LED Rectangular Serie Bure 24W



102. Campana LED Menie 28W



103. Downlight Proyector LED Track (UGR 19)



104. Downlight Proyector LED Navi CCT



105. Carpeta Poster LED a 2 Caras

106. TIRAS LED



107. Tira de LED Videny 60 LED/m



107. Tira de LED FlexiLight 60 LED/m



107. Tira de LED Purple 60 LED/m



108. Tira de LED Videny 60 LED/m



108. Tira de LED Digital Ritt 60 LED/m RGBX



108. Tira de LED Digital Messe 60 LED/m RGBX



110. Tira de LED Digital Tips 120 LED/m



111. Tira de LED Serie Clasic 120 LED/m RGB



111. Tira de LED Clasic 120 LED/m RGB



111. Tira de LED Serie Clasic 120 LED/m



112. Tira LED Videny 60 LED/m



112. Tira de LED Ziadna



113. Tira de LED Videny 60 LED/m



113. Tira de LED Ziadna 120 LED/m



113. Tira de LED Serie Letters 120 LED/m



114. Tira LED Ziadna 192 LED/m



114. Tira de LED Half (5mm de ancho)



114. Tira de LED CobLED Nake 768 LED/m



114. Tira de LED CobLED Nake 280 LED/m



115. Barra LED Para Estanterías



116. Pack Tira de LED Solar 300L



116. Pack Tira de LED Solar 300L



118. Pack Tira de LED 12V 60 LED/m CCT



118. Pack Tira de LED 12V 30 LED/m RGB



119. Pack Tira de LED 24V 16 LED/m



120. Aplique LED Solar Natur con Sensor Movimiento



121. Tira de LED Ruzok 220V 120 LED/m



121. Tira de LED Brescia 220V 110 LED/m



122. Tira de LED Cobpro 220V



122. Tira de LED RGB Fast 60 LED/m

INDICE



122. Tira de LED Fast 120 LED/m



123. Tira de LED Bergamo



123. Tira de LED Como 220V 110 LED/m



123. Tira de LED Arast 220V 180 LED/m



124. Neón de LED Flexible Prozny 220V



124. Neón de LED Flexible Prozny 220V



124. Neón de LED Flexible Prozny 220V



125. Neón de LED Flexible Letters



126. Fuentes de Alimentación Mean Well Para tiras LED



126. Fuentes de Alimentación Para tiras LED



126. Fuentes de Alimentación Slim Para tiras LED



127. Fuentes de Alimentación Dimable por Triac



128. Fuentes de Alimentación Dimable 0-10V



129. Fuente de Alimentación Para tiras LED (Especial para perfiles)



129. Fuentes de Alimentación Para tiras LED



129. Fuentes de Alimentación Para Tiras LED



130. Fuentes de Alimentación Mean Well Para tiras LED



130. Adaptador de Corriente Para Tiras LED 36W



130. Adaptador de Corriente Para Tiras LED 120W



130. Adaptador de Corriente Para tiras LED RGB 60W



130. Adaptador de Corriente Para tiras LED RGB 60W



131. Adaptador de Corriente Para tiras LED RGB 60W



131. Dimmer Empotrable Táctil



131. Controlador LED Táctil



131. Dimmer Monocolor Para Tiras LED



132. Amplificador de Señal



132. Amplificador de Señal Rgb



132. Dimmer Por Infrarrojos Para Tira LED



132. Interruptor Con Sensor de Movimiento Para Tira LED



133. Interruptor Táctil Para Tira LED



133. Conector Ultramini



133. Conector Intermedio Para Tira LED IP68



133. Conector Para Tira LED



134. Conector de Hipopótamo Para Tira LED



134. Conector de Hipopótamo Para Tira LED y Cable



134. Conector de Hipopótamo Tipo L Para Tira LED



135. Roldana para Tiras LED



135. Controlador Mini Para Tiras LED Rgb



135. Controlador Mini Smarthome Para Tiras LED Rgb



135. Controlador LED Táctil Rgb+Cct



136. Controlador Mini Para Tiras LED Cct



136. Controlador Wifi Para Tiras LED Rgb+Cct



136. Controlador Mini Para Tiras LED Rgb



136. Controlador Mini Para Tiras LED Rgbw



137. Controlador Para Tiras LED Rgb+C/rgb+W



137. Controlador Wifi Para Tiras LED Rgb+C/rgb+W



137. Controlador Wifi Rgb+Cct App Magic Home



137. Controlador Para Tiras LED Rgb Fast



138. Controlador LED Rgb Fast 220V



138. Controlador Neón Led Rgb 220V



138. Controlador Para Tira LED 220V Mixt



138. Rectificador Tira LED 220V Smd 2835 Fast



139. Rectificador Tira LED 220V Smd 2835 Arast



139. Rectificador Neón LED Monocolor 220V



139. Controlador M-4000 Para Tira LED Digital Ritt / Messe

140. INDUSTRIAL



141. Campana UFO LED Inspire



142. Campana LED SMD Cool



143. Elevador Para Campanas Industriales



144. Campana UFO LED Serie A 1-10V



146. Campana LED Infinity

148. ALUMBRADO PUBLICO



149. Farola LED Light Series Pro



150. Farola Solar LED Solights Para Alumbrado Público



151. Farola Solar LED Urban Para Alumbrado Público



152. Farola Solar Led Para Alumbrado Público 20W Con Sensor



153. Farol Villa Acero Pintado Horno Negro



154. Farola Solar LED Kain Para Alumbrado Público



155. Farola LED Serie Harlem



156. Farola LED Line Series

158. COMPONENTES



159. Driver Philips Certadrive No Flicker



159. Driver Lifud Regulable 0-10V LF-AAA040B1050-42



159. Driver Para Panel de 60X60



159. Driver para panel LED de 60x60



160. Driver Lifud Regulable 1-10V - LF-GDE030YF



160. Driver Lifud Regulable Triac - LF-GDE030YG No Flicker



160. Farola LED Serie Harlem



160. Farola LED Line Series



161. Driver Lifud Regulable Dali - LF-GSD030PF No Flicker



161. Driver para panel de 60x60 42W



161. Driver Downlight Panel LED 6W



161. Driver Downlight Panel LED 9W



162. Driver Downlight Panel LED 12W



162. Driver Downlight Panel LED 20W

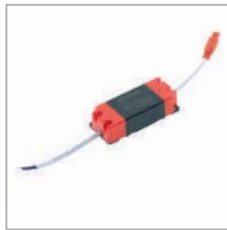

162. Driver Downlight Panel LED 25W



162. Driver Lifud 40W LF-GIR040YM1000H



163. Driver Lifud 30W LF-GIR030YM750H



163. Driver Lifud Regulable Dali - LF-GDE042YF No Flicker



163. Kit de Conversión de Emergencia hasta 20W



164. Kit de Conversión de Emergencia hasta 50W LF-GSP012YG



165. Pasarela Conversor 1-10V 2 Hilos a DALI



166. Conector rápido de 3 entradas hasta 4 mm²



166. Regleta con clip 3 polos conexión rápida



166. Linterna LED Feather Multifunción con Imán



166. Linterna LED SurfLED con Gancho e imán IP65 + Función Power Bank



168. Mando Control para Campana Serie A



168. Sensor de Movimiento Radar IP65 Para Campana Serie A



168. Regulador LED 0-10V



168. Kit Aro / Anillo de Luz LED Selfie



169. Aplique LED World con sensor de movimiento



169. Aplique LED Hearth con sensor de movimiento



169. BisaLight LED para Bisagra



169. Extractor Ofair 60X60 cm



170. Extractor Hadary 15W



170. Protector Sobretensiones 10Kv SOSEN



170. Control Remoto - App Smart Life

172. DETECTORES



173. Detector de movimiento PIR 180° Superficie



173. Detector de movimiento PIR 180° Superficie



173. Detector de Movimiento PIR Mini 360° Superficie



173. Detector de Movimiento Infrarrojo 360° Superficie



174. Detector de Movimiento PIR Square 160°



174. Detector de Movimiento PIR 180° Superficie



174. Detector de movimiento Mini PIR 360° Empotrable



174. Detector de movimiento PIR 360° Empotrable



175. Detector de movimiento PIR 360° Empotrable Silver

176. aros y accesorios



177. Chapa adaptación para farol Villa



177. Cinta adhesiva 3M de doble cara 50 metros

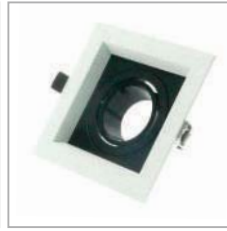

177. Aro Cardan Aras Para Modulo Arumled / GU10 / MR16



177. Aro Cardan Aras Doble Para Modulo Arumled / GU10 / MR16



178. Aro Fijo Redondo Blanco Serie Infinity Para Gu10 / MR16



178. Aro Basculante Redondo Negro Serie Evo Para Gu10 / MR16



178. Aro Basculante Redondo Blanco Serie Evo Para Gu10 / MR16



178. Aro basculante redondo blanco Serie Luxury Para GU10 / MR16



179. Aro basculante redondo níquel Serie Luxury Para GU10 / MR16



179. Aro basculante cuadrado blanco Serie Luxury Para GU10 / MR16



179. Aro basculante cuadrado níquel Serie Luxury Para GU10 / MR16



179. Aro basculante redondo blanco Serie Eco Para GU10 / MR16



180. Aro basculante redondo níquel Serie Eco Para GU10 / MR16



180. Aro basculante cuadrado níquel Serie Eco Para GU10 / MR16

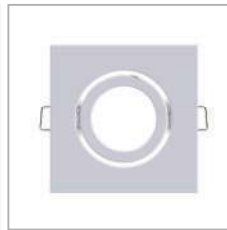

180. Aro basculante cuadrado blanco Serie Eco Para GU10 / MR16



180. Aplique de Techo Berlín Gu10



181. Aplique de Techo Milano Gu10



181. Soporte de pared para Farolas Led



181. Brazo articulado para Foco Infinity 180°



181. Soporte para proyectores LED 730 mm



182. Brazo articulado para Farola 180°



182. Conector en I IP68



182. Conector en Y IP68



182. Conector en T IP68



183. Caja con Cinco Conectores IP68



183. Guirnalda de 10 casquillos E27 Exterior IP65 cable eléctrico



183. Adaptador E27 a E40



183. Adaptador E27 a E40 Cerámico



184. Cable alargador de 2 metros solo compatible con focos solares Venecia



184. Grapas para paneles LED



184. Colgadores para paneles LED



184. Colgadores Para Carril LED

Iluminación led, fabricación, calidad, profesionalidad, eficacia, expertos, modernos, innovadores, polivalentes, creativos, versátiles, entrega.

Led



Led es una compañía líder en la comercialización, y fabricación de material de iluminación y es una de las principales empresas suministradoras de productos para el sector de la iluminación.

Desde el momento de su fundación hasta ahora su objetivo ha sido ofrecer productos de alta calidad para dar solución y buen servicio a, diseñadores, almacenes y establecimientos de la industria de la iluminación.

Actualmente concentramos todos nuestros recursos en distribuir toda una gama de productos de ahorro energético y conseguir la máxima eficiencia energética.

Nuestra oferta principal consiste en sistemas de iluminación **LED** que ofrecen una alta calidad y valor añadido a nuestros clientes.

Continuamente invertimos en nuestro Departamento Técnico y nos hallamos en una búsqueda constante de nuevos partners para contribuir con nuestro proyecto al desarrollo e innovación de la tecnología.

Empresa Dinámica

Iniciativa y gestión para suministrar productos y servicios anticipándonos a la demanda del mercado.

Alta Calidad

En nuestro trabajo, servicios y productos.

Innovación

Obtención de productos y servicios para cubrir las necesidades de nuestros clientes, intentando suministrar los avances tecnológicos del mercado.

Continúa mejora con nuestros clientes

Este es nuestro principal objetivo.

Trabajo ético

Es la base de todas nuestras actividades con nuestros clientes, proveedores, trabajadores y en general con la sociedad.

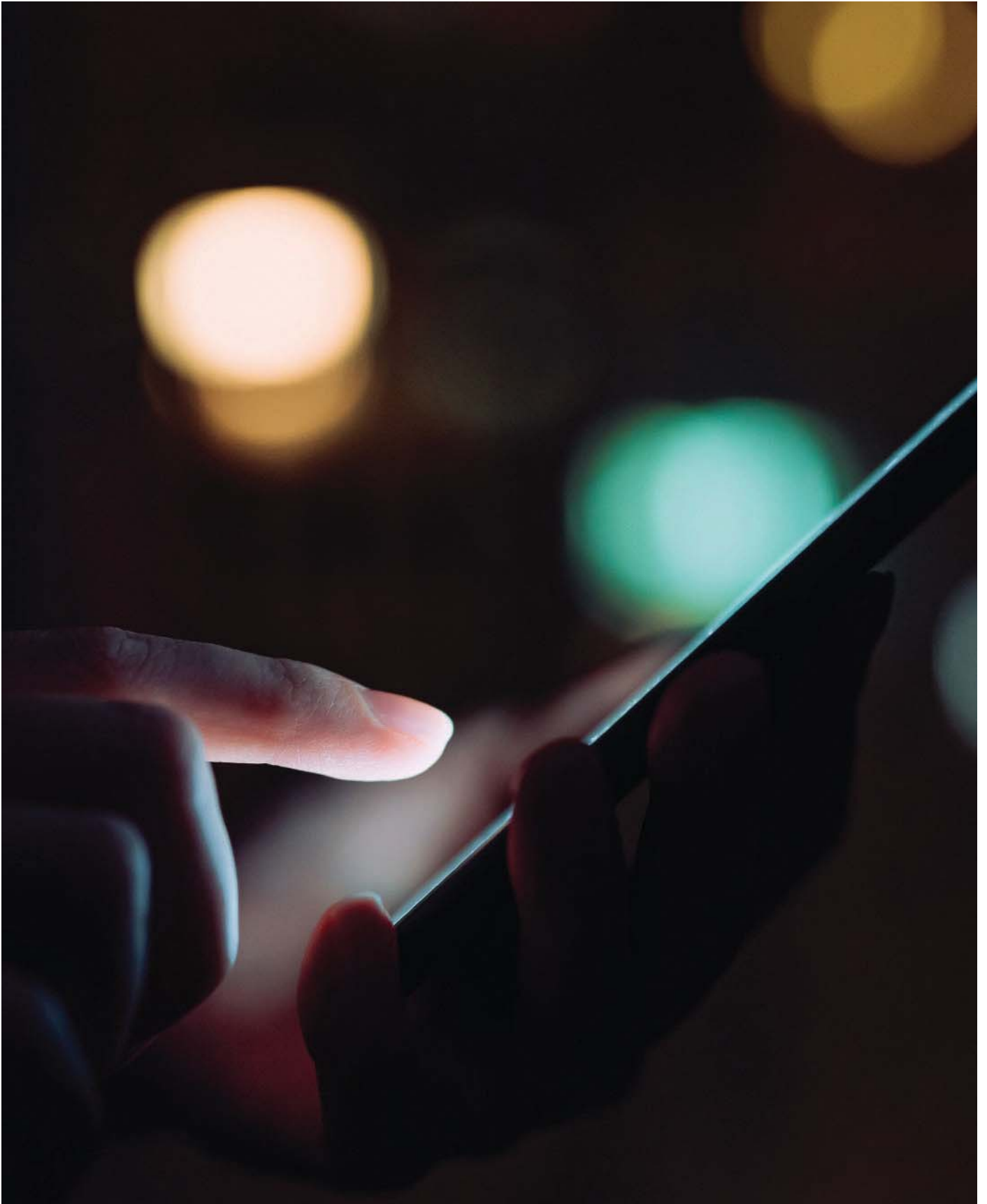

SMARTHOME

Iluminación Decorativa / SmartHome / Lámparas de Pie LED

M Lámpara de pie Coright CCT



GARANTÍA
3 AÑOS



Ref	Vatios	Lm	Acabado	Dimensión	Material	Temperatura de color	PREZZO IVA escl.
LM8401	20	1600	Negro	170X200X1500H mm	Metal	CCT	114,00

conf. scatol.

1 pz	1 pz	IP20	30000 H	120°	180°	-20°C + 40°C	CRI 80	Receptor wifi 2.4 GHz
------	------	------	---------	------	------	-----------------	-----------	-----------------------------

Iluminación Interior / Bombillas LED / Bombillas LED E14 / SmartHome

M Bombilla LED SmartHome G45 6W



GARANTÍA
3 AÑOS



Ref	Vatios	Lm	Acabado	Dimensión	Material	Temperatura de color	PREZZO IVA escl.
LM7145	6	600	Opal	45X78H mm	Aluminio / PC	RGB+CCT	15,90

conf. scatol.

10 pz	100 pz	IP20	20000 H	AC 220 240V	240°	CRI 80	Receptor wifi 2.4 GHz
-------	--------	------	---------	----------------	------	-----------	-----------------------------

Iluminación Interior / Bombillas LED / Bombillas LED E14 / SmartHome

M Bombilla LED SmartHome C37 6W



GARANTÍA
3 AÑOS



Ref	Vatios	Lm	Acabado	Dimensión	Material	Temperatura de color	PREZZO IVA escl.
LM7144	6	600	Opal	37X108H mm	Aluminio / PC	RGB+CCT	15,90

conf. scatol.

10 pz	100 pz	IP20	20000 H	AC 220 240V	240°	CRI 80	Receptor wifi 2.4 GHz
-------	--------	------	---------	----------------	------	-----------	-----------------------------

Iluminación Interior / Bombillas LED / Bombillas LED E27 / SmartHome

M Bombilla LED SmartHome E27 A60 10W



GARANTÍA
3 AÑOS



Ref	Vatios	Lm	Acabado	Dimensión	Material	Temperatura de color	PREZZO IVA escl.
LM7141	10	1000	Opal	123X60H mm	Aluminio / PC	RGB+CCT	18,90

conf. scatol.

10 pz	50 pz	IP20	20000 H	AC 220 240V	240°	CRI 80	Receptor wifi 2.4 GHz
-------	-------	------	---------	----------------	------	-----------	-----------------------------

Iluminación Interior / Bombillas LED / Bombillas LED GU10 / MR16 / SmartHome

M Bombilla LED SmartHome GU10 5W



GARANTÍA
3 AÑOS



Ref	Vatios	Lm	Acabado	Dimensión	Material	Temperatura de color	PREZZO IVAescl.
LM7140	5	500	Opal	50X55H mm	Aluminio / PC	RGB+CCT	19,90

conf. scatol.

10 pz	50 pz	IP20	20000 H	AC 220 240V	240°	CRI 80	Receptor wifi 2.4 GHz
-------	-------	------	---------	-------------	------	--------	-----------------------

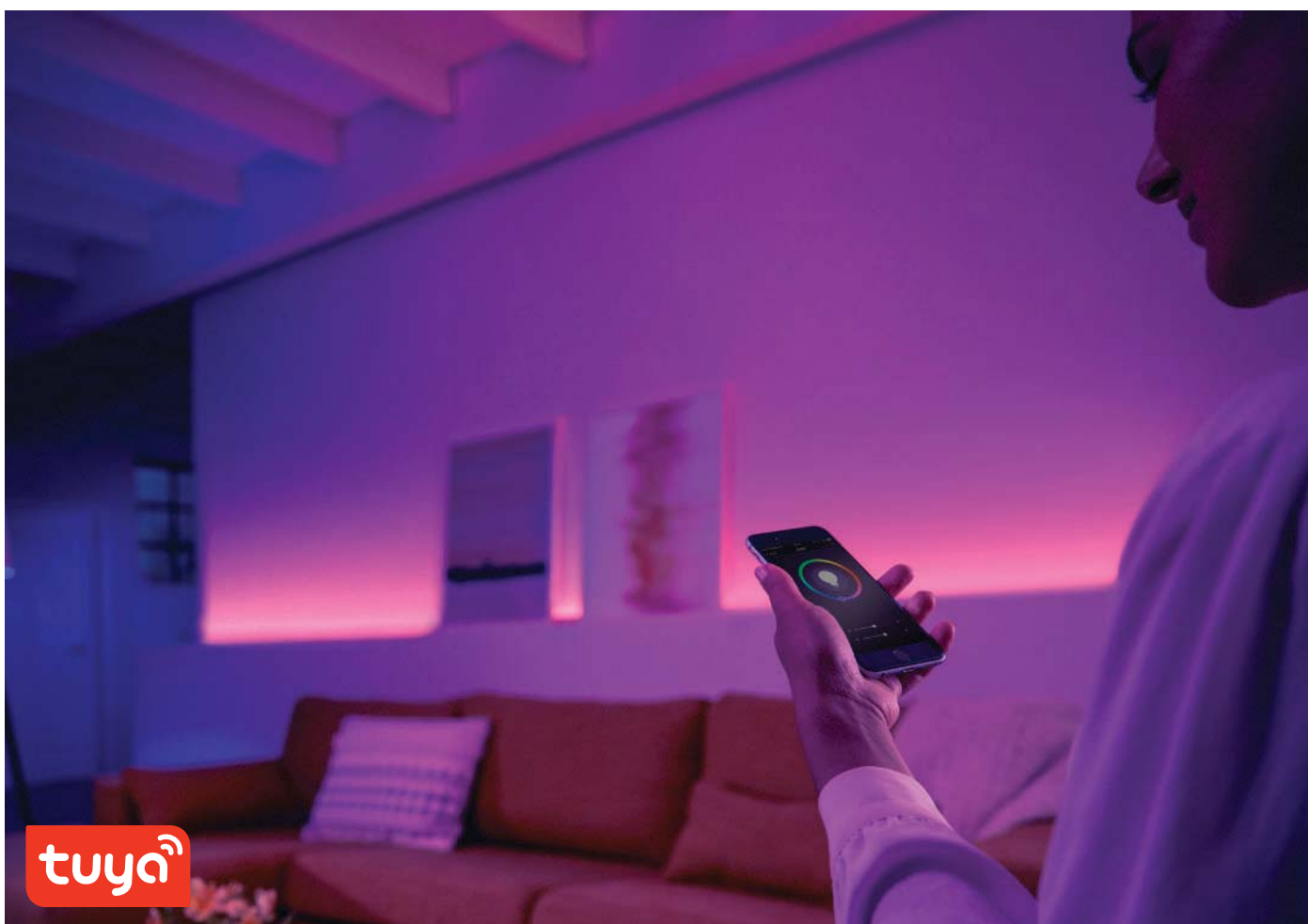

Iluminación con millones de combinaciones

El modo de color RGB (Rojo, Verde, Azul) es un modelo de color orientado al hardware.

El sistema adopta el modelo de color RGB para la visualización de imágenes. El modelo de color RGB pertenece al principio de mezcla de colores aditivos. Cuanto mayor sea el valor de cada color primario, más brillante será el color.

Cuando RGB es 0, es negro y cuando RGB es 255, es blanco. Una lámpara RGB tiene colores de luz ajustables. Se superponen de varias maneras para reproducir una amplia gama de colores.

Es uno de los modelos de color más utilizados. Un sistema RGB puede tener 16.777.216 (2563) colores posibles. El sistema RGB también se denomina RGB24 (modo de 24 bits).

Como modelo orientado al hardware el sistema se adapta a la adición de colores. Cuanto mayor sea el valor de cada color primario, más brillante será el color. Cuando RGB es 0, es negro y cuando RGB es 255, es blanco.

La iluminación explicada en RGB nos dice que la luz está compuesta por ondas de energía, que

cuando se combinan se llaman espectro. Las diferentes luces que vemos están compuestas de diversos colores. Al final de cada espectro, **hay una longitud de onda corta**, y ese es el color azul. En el otro extremo del espectro hay **una longitud de onda más**, que es el color rojo. Las otras luces que vemos en el espectro están entre el rojo y el azul.



Iluminación Interior / Downlight LED / SmartHome

M Downlight LED SmartHome Nail 9W



GARANTÍA 3 AÑOS



Ref	Vatios	Lm	Acabado	Dimensión	Material	Temperatura de color	PREZZO IVAescl.
LM4280	9	810	Blanco	113X58H mm	Aluminio / PC	RGB+CCT	29,00

conf. scatol.

1 pz	50 pz	IP20	30000 H	AC 220 240V	120°	CRI 80	Receptor wifi 2.4 GHz	Corte 90 mm
------	-------	------	---------	-------------	------	--------	-----------------------	-------------

Iluminación Interior / Plafones LED / SmartHome

M Plafón LED SmartHome Dial 24W



GARANTÍA 3 AÑOS



Ref	Vatios	Lm	Acabado	Dimensión	Material	Temperatura de color	PREZZO IVAescl.
LM8233	24	3000	Blanco	390X65H mm	Aluminio / PC	CCT	43,90

conf. scatol.

1 pz	1 pz	IP20	30000 H	AC 170 265V	180°	CRI 80	Receptor Bluetooth
------	------	------	---------	-------------	------	--------	--------------------

Iluminación Exterior / Plafones LED de Exterior / SmartHome

M Plafón LED SmartHome RainBow Wifi App CCT



GARANTÍA 3 AÑOS



Ref	Vatios	Lm	Acabado	Dimensión	Material	Temperatura de color	PREZZO IVAescl.
LM8230	24	2400	Blanco	280X48H mm	Aluminio / PC	CCT	69,00

conf. scatol.

1 pz	1 pz	IP54	30000 H	AC 220 240V	120°	CRI 80	Receptor wifi 2.4 GHz
------	------	------	---------	-------------	------	--------	-----------------------

Iluminación Interior / Paneles LED / SmartHome

M Panel LED SmartHome RGB+CCT



GARANTÍA 3 AÑOS



Ref	Vatios	Lm	Acabado	Dimensión	Material	Temperatura de color	PREZZO IVAescl.
LM5304	40	3800	Blanco	595X595X10H mm	Aluminio	RGB+CCT	159,00

conf. scatol.

1 pz	6 pz	IP40	AC 110 240V	40000 H	AC 110 240V	120°	-10°C + 50°C	CRI 80	UGR 19
------	------	------	-------------	---------	-------------	------	--------------	--------	--------

Sincronizando necesidades



La solución de sincronización se basa en el desarrollo del módulo de modo dual Wi-Fi y Bluetooth LE de alto rendimiento de Tuya.

Es compatible con enlaces de control dual para el control remoto de Wi-Fi y el control local de Bluetooth, y puede realizar una conmutación perfecta automática e inteligente, lo que puede ocurrir en entornos de red de Wi-Fi deficientes.

En el caso de fluctuaciones, aún se puede garantizar un control fluido del usuario, lo que puede mejorar en gran medida la experiencia del usuario. Además, la solución admite puntos de función enriquecidos, como el control remoto por infrarrojos, la atenuación segmentada, el modo de no molestar, el biorritmo, etc.

También proporciona una variedad de paneles de control para que los clientes elijan, lo que es adecuado para la inteligentización de varios tipos de productos de iluminación.

Los asistentes de voz "Hey Alexa - Show Us Around" pueden llevar sus apartamentos inteligentes al siguiente nivel, proporcionando una experiencia verdaderamente sin contacto para los residentes. Vincule dispositivos inteligentes y escenas con sus parlantes para que tanto los residentes actuales como los futuros puedan disfrutar de la experiencia del hogar inteligente desde el primer momento.



Iluminación Exterior / SmartHome / Proyector LED RGB

M Foco Proyector LED SmartHome



GARANTÍA
3 AÑOS



Ref	Vatios	Lm	Acabado	Dimensión	Material	Temperatura de color	PREZZO IVAescl.
LM6519	50	3750	Negro	164,2X31,7X194,9H mm	Aluminio / PC	CCT+RGB	69,90
LM6520	100	7500	Negro	198,6X33X194,9H mm	Aluminio / PC	CCT+RGB	86,00

conf. scatol.

1 pz	10 pz	IP65	30000 H	AC 220 240V	120°	-20°C + 45°C	CRI 80	Receptor wifi 2.4 GHz
------	-------	------	---------	-------------	------	--------------	--------	-----------------------



App

Nos centramos en la innovación de todos nuestros productos, mientras brindamos a los usuarios experiencias únicas e interactivas para impulsar la competitividad en el mercado.

Nuestras aplicaciones admiten varios idiomas, incluidos chino, inglés, alemán, francés y japonés.

La localización de idiomas continuamente actualizada y mejorada lo ayudará a ingresar sin problemas a un mercado extranjero.

Automatización completa del hogar, compartiendo el acceso al hogar inteligente con miembros de la familia y estableciendo permisos de acceso específicos para miembros; Obtenga información sobre el clima local y la calidad del aire en tiempo real.

El centro de control central para que sus residentes administren y personalicen sus hogares inteligentes: una aplicación descargable diseñada y creada por nosotros, pero hecha para su disfrute.

Tuya Smart es una plataforma global de desarrollo de IoT que crea estándares de interconectividad para satisfacer las necesidades inteligentes de marcas, OEM, desarrolladores y cadenas minoristas en una amplia gama de industrias y dispositivos inteligentes.

Basado en la nube pública global, Tuya conecta diferentes escenarios inteligentes y dispositivos inteligentes proporcionando herramientas de desarrollo de hardware, integrando servicios de nube global y ofreciendo una plataforma de desarrollo empresarial inteligente.

Tuya proporciona un empoderamiento inteligente integral desde la tecnología hasta el marketing para fomentar un ecosistema de desarrolladores neutral, abierto y accesible.



Componentes Eléctricos / SmartHome

M Enchufe Wifi SmartHome 16A



GARANTÍA 3 AÑOS



Ref	Acabado	Dimensión	Material	PREZZO IVA escl.
LM9101	Blanco	45X85H mm	Metal / PC	25,60

conf. scatol.

1 pz	144pz	IP20	AC 100 240V	POT MAX. 3520W	INT CORRIENTE 16A	Receptor wifi 2.4 GHz
------	-------	------	-------------	----------------	-------------------	-----------------------

Tiras LED y Neón LED / Accesorios Tiras LED 12V / Accesorios Tiras LED 24V / SmartHome

M Controlador Mini Para Tiras LED RGB Control remoto por IR / APP Magic Home



GARANTÍA 3 AÑOS



Ref	Acabado	Dimensión	Material	PREZZO IVA escl.
LM2187	Blanco	50X22X10H mm	PC	27,90

conf. scatol.

1 pz	100pz	IP20	DC 12 24V	POT MAX. 72 (12V) 144 (24V) DC	Receptor wifi 2.4 GHz
------	-------	------	-----------	--------------------------------	-----------------------

Iluminación Interior / SmartHome

M Controlador Wifi Rgb+Cct



GARANTÍA 3 AÑOS



Ref	Acabado	Dimensión	Material	PREZZO IVA escl.
LM2186	Blanco	83X63X17H mm	Metal / PC	43,90

conf. scatol.

1 pz	100pz	IP20	DC 12 24V	POT MAX. 96 (12V) 192 (24V) DC	Receptor wifi 2.4 GHz
------	-------	------	-----------	--------------------------------	-----------------------

Tiras LED y Neón LED / Fuentes de Alimentación Interior 24V / SmartHome

M Fuente de Alimentación Dimable Por APP Tuya LED 24V dc RGB+CCT



GARANTÍA 3 AÑOS



Ref	Vatios	Acabado	Dimensión	Material	PREZZO IVA escl.
LM2256	200	Negro	230X49X29H mm	Aluminio	55,90
LM2257	400	Negro	288X49X29H mm	Aluminio	87,00

conf. scatol.

1 pz	45pz	IP20	AC 200 240V	POT MAX. 200-400W	F.P 0.90	24V DC	Receptor Bth Mesh 5.0
------	------	------	-------------	-------------------	----------	--------	-----------------------



ILUMINACIÓN INTERIOR

Iluminación Interior / Bombillas LED / Bombillas LED E27

M Bombilla LED Colours Gu10 5W Rgbw Con Mando



GARANTÍA
3 AÑOS

Ref	Lm	Vatios	Acabado	Dimensión	Material	Temperatura de color	PREZZO IVAescl.
LM7142	350	5	Opal	50X56H mm	Aluminio / PC	RGBW	9,95

conf. scatol.

10 pz	100 pz	IP20	30000 H	AC 170 265V	38°	CRI 80
-------	--------	------	---------	-------------	-----	--------

Iluminación Interior / Bombillas LED / Bombillas LED E27

M Bombilla LED Colours A60 E27 10W Rgbw Con Mando



GARANTÍA
3 AÑOS

Ref	Lm	Vatios	Acabado	Dimensión	Material	Temperatura de color	PREZZO IVAescl.
LM7143	1000	10	Opal	115HX60 mm	Aluminio / PC	RGBW	11,50

conf. scatol.

10 pz	100 pz	IP20	30000 H	AC 170 265V	270°	CRI 80
-------	--------	------	---------	-------------	------	--------

Iluminación Interior / Bombillas LED / Bombillas LED E27

M Bombilla LED E27



GARANTÍA
3 AÑOS

Ref	Lm	Vatios	Acabado	Alimentación	Dimensión	Material	Temperatura de color	PREZZO IVAescl.
LM7002	450	5	Opal	AC 170-265V	45X83H mm	Aluminio / PC	4500 K	1,95
LM7003	450	5	Opal	AC 170-265V	45X83H mm	Aluminio / PC	6000 K	1,95
LM7004*	450	5	Opal	AC 170-265V	45X83H mm	Aluminio / PC	3000 K	1,95
LM7005	630	7	Opal	AC 170-265V	45X90H mm	Aluminio / PC	4500 K	2,25
LM7006	630	7	Opal	AC 170-265V	45X90H mm	Aluminio / PC	6000 K	2,25
LM7007*	630	7	Opal	AC 170-265V	45X90H mm	Aluminio / PC	3000 K	2,25
LM7035	820	10	Opal	AC 180-240V	59X116H mm	Aluminio / PC	6000 K	2,70
LM7036	820	10	Opal	AC 180-240V	59X116H mm	Aluminio / PC	4500 K	2,70
LM7037*	820	10	Opal	AC 180-240V	59X116H mm	Aluminio / PC	3000 K	2,70
LM7046	1350	15	Opal	AC 180-240V	69X130H mm	Aluminio / PC	6000 K	3,39
LM7047	1350	15	Opal	AC 180-240V	69X130H mm	Aluminio / PC	4500 K	3,39
LM7048*	1350	15	Opal	AC 180-240V	69X130H mm	Aluminio / PC	3000 K	3,39

conf. scatol.

10 pz	100 pz	IP20	15000 H	AC 170 265V	270°	CRI 80
-------	--------	------	---------	-------------	------	--------

*ordinabili

Iluminación Interior / Bombillas LED / Bombillas LED E14

M Bombilla LED E14



GARANTÍA 3 AÑOS

Ref	Lm	Vatios	Acabado	Dimensión	Material	Temperatura de color	PREZZO IVA escl.
LM7011	630	7	Opal	45X70H mm	Aluminio / PC	4500 K	2,18
LM7012	630	7	Opal	45X70H mm	Aluminio / PC	6000 K	2,18
LM7013*	630	7	Opal	45X70H mm	Aluminio / PC	3000 K	2,18

conf. scatol.

10 pz	100 pz	IP20	15000 H	AC 170 265V	270°	CRI 80
-------	--------	------	---------	-------------	------	--------

Iluminación Interior / Bombillas LED / Bombillas LED E14

M Bombilla LED E14 R50



GARANTÍA 3 AÑOS

Ref	Lm	Vatios	Acabado	Dimensión	Material	Temperatura de color	PREZZO IVA escl.
LM7081	520	6	Opal	50X87H mm	Aluminio / PC	6000K	2,89
LM7083*	520	6	Opal	50X87H mm	Aluminio / PC	3000K	2,89

conf. scatol.

10 pz	100 pz	IP20	15000 H	AC 170 265V	120°	CRI 80
-------	--------	------	---------	-------------	------	--------

Iluminación Interior / Bombillas LED / Bombillas LED E27

M Bombilla LED E27 R80



GARANTÍA 3 AÑOS

Ref	Lm	Vatios	Acabado	Dimensión	Material	Temperatura de color	PREZZO IVA escl.
LM7084	810	9	Opal	63X100H mm	Aluminio / PC	6000 K	3,19
LM7086*	810	9	Opal	63X100H mm	Aluminio / PC	3000 K	3,19
LM7087	1080	12	Opal	80X115H mm	Aluminio / PC	6000 K	4,30
LM7089*	1080	12	Opal	80X115H mm	Aluminio / PC	3000 K	4,30
LM7090	1350	15	Opal	90X116H mm	Aluminio / PC	6000 K	6,75
LM7092*	1350	15	Opal	90X116H mm	Aluminio / PC	3000 K	6,75

conf. scatol.

10 pz	100 pz	IP20	15000 H	AC 170 265V	120°	CRI 75
-------	--------	------	---------	-------------	------	--------

Iluminación Interior / Bombillas LED / Bombillas LED E14

M Bombilla LED C37 E14



GARANTÍA 3 AÑOS

Ref	Lm	Vatios	Acabado	Dimensión	Material	Temperatura de color	PREZZO IVA escl.
LM7021	500	6	Opal	37X100 mm	Aluminio / PC	6000K	2,15
LM7022	500	6	Opal	37X100 mm	Aluminio / PC	4500K	2,15
LM7023	500	6	Opal	37X100 mm	Aluminio / PC	3000K	2,15

conf. scatol.

10 pz	100 pz	IP20	15000 H	AC 170 265V	270°	CRI 80
-------	--------	------	---------	-------------	------	--------

*ordinabili

Iluminación Interior / Bombillas LED

M Bombilla LED E27 Serie T



GARANTÍA
3 AÑOS



Ref	Lm	Vatios	Acabado	Dimensión	Material	Temperatura de color	PREZZO IVA escl.
LM7098	2700	30	Opal	98X188H mm	Aluminio / PC	6000 K	13,90
LM7100	4000	50	Opal	125X221H mm	Aluminio / PC	6000 K	26,90

conf. scatol.

10 pz	30 pz	IP20	15000 H	AC 170 265V	270°	- 20°C + 40°C	CRI 80
-------	-------	------	---------	----------------	------	------------------	-----------

Iluminación Interior / Bombillas LED

M Bombilla LED E27 Industrial Iris



GARANTÍA
3 AÑOS



Ref	Lm	Vatios	Acabado	Dimensión	Material	Temperatura de color	PREZZO IVA escl.
LM7201	5500	50	Opal	175X246H mm	Aluminio / PC	6500 K	39,50
LM7204	11000	100	Opal	175X246H mm	Aluminio / PC	6500 K	52,50
LM7207	16500	150	Opal	175X246H mm	Aluminio / PC	6500 K	72,50

conf. scatol.

1 pz	24 pz	IP40	30000 H	AC 170 265V	270°	CRI 80
------	-------	------	---------	----------------	------	-----------

Iluminación Interior / Bombillas LED / Bombillas LED E27

M Bombilla LED E27 G125



GARANTÍA
3 AÑOS



Ref	Lm	Vatios	Acabado	Dimensión	Material	Temperatura de color	PREZZO IVA escl.
LM7091	1350	15	Opal	95X138H mm	Aluminio / PC	6000 K	10,90
LM7093	1350	15	Opal	95X138H mm	Aluminio / PC	4500 K	10,90
LM7094	1350	15	Opal	95X138H mm	Aluminio / PC	3000 K	10,90
LM7095	1800	20	Opal	118X156,5H mm	Aluminio / PC	6000 K	11,30
LM7096	1800	20	Opal	118X156,5H mm	Aluminio / PC	4500 K	11,30
LM7097	1800	20	Opal	118X156,5H mm	Aluminio / PC	3000 K	11,30

1 pz	24 pz	IP20	15000 H	AC 170 265V	300°	CRI 80
------	-------	------	---------	----------------	------	-----------

conf. scatol.

Iluminación Interior / Bombillas LED / Bombillas LED GU10

M Bombilla LED AR111



GARANTÍA
3 AÑOS



Ref	Lm	Vatios	Acabado	Dimensión	Material	Temperatura de color	PREZZO IVA escl.
LM7155*	1200	15	Cromo	110X75H mm	Aluminio / PC	4500 K	20,90
LM7156*	1200	15	Cromo	110X75H mm	Aluminio / PC	3000 K	20,90

conf. scatol.

1 pz	1 pz	IP20	30000 H	AC 170 250V	24°	CRI 80
------	------	------	---------	----------------	-----	-----------

*ordinabili

M

Iluminación Interior / Bombillas LED / Bombillas LED GU10 / MR16

**Bombilla LED GU10
Smd Plus**GARANTÍA
3 AÑOS

Ref	Lm	Vatios	Acabado	Dimensión	Material	Temperatura de color	PREZZO IVA escl.
LM7074	580	7	Opal	50X55H mm	Termoplastico / PC	6000 K	2,59
LM7075	580	7	Opal	50X55H mm	Termoplastico / PC	4500 K	2,59
LM7076*	580	7	Opal	50X55H mm	Termoplastico / PC	3000 K	2,59

conf. scatol.

10 pz

100 pz

IP20

15000 H

AC 170
265V

100°

CRI
80**M**

Iluminación Interior / Bombillas LED / Bombillas LED GU10 / MR16

**Bombilla LED Mr16
Smd Plus**GARANTÍA
3 AÑOS

Ref	Lm	Vatios	Acabado	Dimensión	Material	Temperatura de color	PREZZO IVA escl.
LM7055	580	7	Opal	50X55H mm	Termoplastico / PC	6000 K	2,99
LM7056	580	7	Opal	50X55H mm	Termoplastico / PC	4500 K	2,99
LM7057*	580	7	Opal	50X55H mm	Termoplastico / PC	3000 K	2,99

conf. scatol.

10 pz

100 pz

IP20

15000 H

AC 220
240V

100°

CRI
80**M**

Iluminación Interior / Bombillas LED / Bombillas LED E14

Bombilla LED G45 E14GARANTÍA
3 AÑOS

Ref	Lm	Vatios	Acabado	Dimensión	Material	Temperatura de color	PREZZO IVA escl.
LM7131*	520	7	Translucido	45X70H mm	Termoplastico	Azul	3,19
LM7132*	520	7	Translucido	45X70H mm	Termoplastico	Azul oscuro	3,19
LM7133*	520	7	Translucido	45X70H mm	Termoplastico	Amarillo	3,19

conf. scatol.

10 pz

100 pz

IP20

15000 H

AC 170
265V

270°

CRI
80

Iluminación Interior / Bombillas LED

M Bombilla LED E27 Antimosquitos



GARANTÍA
3 AÑOS



Ref	Lm	Vatios	Acabado	Dimensión	Material	Temperatura de color	PREZZO IVA escl.
LM9006	1280	15	Opal	160X90H mm	Aluminio / PC	6000 K	10,90

conf. scatol.

10 pz

20 pz

IP20

30000 H

AC 170
265V

300°

CRI
80

Acaba de una vez con los mosquitos!!!

¿Cansado de que te piquen los mosquitos o de no hacer muchos planes para evitar sus picaduras? Ahora con esta bombilla antimosquitos conseguirás eliminar los mosquitos de forma eficaz, tanto al aire libre como en interiores.

Tener una lámpara antimosquitos es una de las soluciones más efectivas para evitar a estos molestos insectos. La lámpara antimosquitos es un dispositivo que emite una luz ultravioleta y fluorescente que atrae a los insectos.

Esta bombilla E27 está especialmente diseñada para atraer a los mosquitos y cuenta con unos filamentos electrificados que eliminan los mosquitos sin necesidad de utilizar productos químicos.



Ligero y portátil

Este matamosquitos es liviano y portátil. El gancho resistente y retráctil es perfecto para colgarlo en cualquier lugar que lo necesite, puede colocarlo en una cuerda o rama de un árbol o colocarlo sobre una mesa para iluminarlo.

Amplia gama de aplicaciones: Doble uso para interiores y exteriores. Ideal para dormitorios, salas de estar, baños, oficinas, hoteles, campings, patios, etc.



Iluminación Interior / Bombillas LED / Bombillas LED E27

M Bombilla LED Filamento E27 Ámbar



GARANTÍA
3 AÑOS



Ref	Lm	Vatios	Acabado	Dimensión	Material	Temperatura de color	PREZZO IVA escl.
LM8551	350	4	Ámbar	45X73H mm	Cristal	2300 K	2,79
LM8554	350	4	Ámbar	60X104H mm	Cristal	2300 K	3,10
LM8557	500	6	Ámbar	80X120H mm	Cristal	2300 K	6,80
LM8559	500	6	Ámbar	95X135H mm	Cristal	2300 K	6,90
LM8561	500	6	Ámbar	125X176H mm	Cristal	2300 K	9,40

conf. scatol.

10 pz	100 pz	IP20	30000 H	AC 170 265V	330°	CRI 80
-------	--------	------	---------	-------------	------	--------

Iluminación Interior / Bombillas LED / Bombillas LED E14

M Bombilla LED Filamento E14 G45 Ámbar



GARANTÍA
3 AÑOS



Ref	Lm	Vatios	Acabado	Dimensión	Material	Temperatura de color	PREZZO IVA escl.
LM8552*	350	4	Ámbar	45X73H mm	Cristal	2300 K	2,89

conf. scatol.

10 pz	100 pz	IP20	30000 H	AC 170 265V	330°	CRI 80
-------	--------	------	---------	-------------	------	--------

Iluminación Interior / Bombillas LED / Bombillas LED E14

M Bombilla LED Filamento E14 Ámbar



GARANTÍA
3 AÑOS



Ref	Lm	Vatios	Acabado	Dimensión	Material	Temperatura de color	PREZZO IVA escl.
LM8553	350	4	Ámbar	35X100H mm	Cristal	2300 K	2,89

conf. scatol.

10 pz	100 pz	IP20	30000 H	AC 170 265V	330°	CRI 80
-------	--------	------	---------	-------------	------	--------

Iluminación Interior / Bombillas LED / Bombillas LED E14

M Bombilla LED Filamento E14 Punta Ámbar



GARANTÍA
3 AÑOS



Ref	Lm	Vatios	Acabado	Dimensión	Material	Temperatura de color	PREZZO IVA escl.
LM8564*	350	4	Ámbar	35X110H mm	Cristal	2300 K	2,89

conf. scatol.

10 pz	100 pz	IP20	30000 H	AC 170 265V	330°	CRI 80
-------	--------	------	---------	-------------	------	--------

*ordinabili

Iluminación Interior / Bombillas LED / Bombillas LED E27

M Bombilla LED Filamento E27 ST64 Ámbar



GARANTÍA
3 AÑOS



Ref	Lm	Vatios	Acabado	Dimensión	Material	Temperatura de color	PREZZO IVAescl.
LM8563	500	6	Ámbar	64X148H mm	Cristal	2300 K	6,20

conf. scatol.

10 pz	100 pz	IP20	30000 H	AC 170 265V	330°	CRI 80
-------	--------	------	---------	-------------	------	--------

Iluminación Interior / Bombillas LED / Bombillas LED E27

M Bombilla LED Filamento Espiral E27 ST64 Ámbar



GARANTÍA
3 AÑOS



Ref	Lm	Vatios	Acabado	Dimensión	Material	Temperatura de color	PREZZO IVAescl.
LM8571	350	4	Ámbar	64X140H mm	Cristal	2300 K	8,19

conf. scatol.

10 pz	100 pz	IP20	30000 H	AC 170 265V	330°	CRI 80
-------	--------	------	---------	-------------	------	--------

Iluminación Interior / Bombillas LED / Bombillas LED E27

M Bombilla LED Filamento Espiral E27 Ámbar



GARANTÍA
3 AÑOS



Ref	Lm	Vatios	Acabado	Dimensión	Material	Temperatura de color	PREZZO IVAescl.
LM8572	350	4	Ámbar	200X280H mm	Cristal	2300 K	51,50
LM8574	350	4	Ámbar	125X176H mm	Cristal	2300 K	15,50

conf. scatol.

1 pz	25 pz	IP20	30000 H	AC 170 265V	330°	CRI 80
------	-------	------	---------	-------------	------	--------

Iluminación Interior / Bombillas LED / Bombillas LED E27

M Bombilla LED Filamento Espiral E27 A160 Ámbar



GARANTÍA
3 AÑOS



Ref	Lm	Vatios	Acabado	Dimensión	Material	Temperatura de color	PREZZO IVAescl.
LM8575	350	4	Ámbar	160X270H mm	Cristal	2300 K	43,00

conf. scatol.

1 pz	25 pz	IP20	30000 H	AC 170 265V	330°	CRI 80
------	-------	------	---------	-------------	------	--------

Iluminación Interior / Bombillas LED / Bombillas LED E27

M Bombilla LED Filamento Espiral E27 Botella 62 mm Ámbar



GARANTÍA
3 AÑOS



Ref	Lm	Vatios	Acabado	Dimensión	Material	Temperatura de color	PREZZO IVA escl.
LM8579	350	4	Ámbar	62X170H mm	Cristal	2300 K	17,70

conf. scatol.

1 pz	24 pz	IP20	30000 H	AC 170 265V	330°	CRI 80
------	-------	------	---------	-------------	------	--------

Iluminación Interior / Bombillas LED / Bombillas LED E27

M Bombilla LED Filamento Espiral E27 Botella 70 mm Ámbar



GARANTÍA
3 AÑOS



Ref	Lm	Vatios	Acabado	Dimensión	Material	Temperatura de color	PREZZO IVA escl.
LM8578	350	4	Ámbar	70X270H mm	Cristal	2300 K	21,50

conf. scatol.

1 pz	24 pz	IP20	30000 H	AC 170 265V	330°	CRI 80
------	-------	------	---------	-------------	------	--------

Iluminación Interior / Bombillas LED / Bombillas LED E27

M Bombilla LED Filamento Espiral E27 BT180 Ámbar



GARANTÍA
3 AÑOS



Ref	Lm	Vatios	Acabado	Dimensión	Material	Temperatura de color	PREZZO IVA escl.
LM8577	350	4	Ámbar	180X350H mm	Cristal	2300 K	59,00

conf. scatol.

1 pz	15 pz	IP20	30000 H	AC 170 265V	330°	CRI 80
------	-------	------	---------	-------------	------	--------

Iluminación Interior / Bombillas LED / Bombillas LED E27

M Bombilla LED Filamento Espiral E27 A165 4W Ámbar



GARANTÍA
3 AÑOS



Ref	Lm	Vatios	Acabado	Dimensión	Material	Temperatura de color	PREZZO IVA escl.
LM8576	350	4	Ámbar	165X275H mm	Cristal	2300 K	47,00

conf. scatol.

1 pz	15 pz	IP20	30000 H	AC 170 265V	330°	CRI 80
------	-------	------	---------	-------------	------	--------

Iluminación Interior / Bombillas LED / Bombillas LED E27

M Bombilla LED Filamento Espiral E27 G125 Ball Ámbar



GARANTÍA
3 AÑOS



Ref	Lm	Vatios	Acabado	Dimensión	Material	Temperatura de color	PREZZO IVAescl.
LM8573	350	4	Ámbar	125X170H mm	Cristal	2300 K	18,90

conf. scatol.

1 pz	15 pz	IP20	30000 H	AC 170 265V	330°	CRI 80
------	-------	------	---------	-------------	------	--------

Iluminación Interior / Bombillas LED / Bombillas LED E27

M Bombilla LED E27 PAR30



GARANTÍA
3 AÑOS



Ref	Lm	Vatios	Acabado	Dimensión	Material	Temperatura de color	PREZZO IVAescl.
LM7151	3200	35	Opal	95X120H mm	Aluminio / PC	6000 K	41,50
LM7152	3200	35	Opal	95X120H mm	Aluminio / PC	4500 K	41,50
LM7153*	3200	35	Opal	95X120H mm	Aluminio / PC	3000 K	41,50

conf. scatol.

5 pz	60 pz	IP20	35000 H	AC 85 265V	15°	CRI 80	F.P 0.90
------	-------	------	---------	------------	-----	--------	----------

Iluminación Interior / Bombillas LED / Bombillas LED E14

M Bombilla LED E14 Mini



GARANTÍA
3 AÑOS



Ref	Lm	Vatios	Acabado	Dimensión	Material	Temperatura de color	PREZZO IVAescl.
LM3313	420	5	Translucido	15X55H mm	Epoxy	6000K	4,20
LM3314*	420	5	Translucido	15X55H mm	Epoxy	3000K	4,20

conf. scatol.

10 pz	100 pz	IP40	30000 H	AC 170 265V	300°	CRI 80
-------	--------	------	---------	-------------	------	--------

Iluminación Interior / Bombillas LED / Bombillas LED R7S

M Bombilla LED R7S 118 10W



GARANTÍA
3 AÑOS



Ref	Lm	Vatios	Acabado	Dimensión	Material	Temperatura de color	PREZZO IVAescl.
LM7126*	1000	10	Transparente	20X118H mm	Termoplastico	6000K	12,80
LM7127*	1000	10	Transparente	20X118H mm	Termoplastico	4000K	12,80
LM7128*	1000	10	Transparente	20X118H mm	Termoplastico	3000K	12,80

conf. scatol.

1 pz	20 pz	IP20	20000 H	AC 170 265V	330°	CRI 80
------	-------	------	---------	-------------	------	--------

*ordinabili

Iluminación Interior / Downlight LED

M Downlight LED Deep Cct



GARANTÍA 3 AÑOS



Ref	Lm	Vatios	Acabado	Dimensión	Material	Temperatura de color	PREZZO IVA escl.
LM4311	420	5	Negro	40X25H mm	Aluminio / PC	CCT	18,90
LM4312	420	5	Blanco	40X25H mm	Aluminio / PC	CCT	18,90

conf. scatol.

1 pz	100 pz	IP20	30000 H	AC 85 265V	24°	CRI 80	F.P 0.5	Corte 30 mm
------	--------	------	---------	------------	-----	--------	---------	-------------

Iluminación Interior / Downlight LED

M Downlight LED Didle



GARANTÍA 3 AÑOS



Ref	Lm	Vatios	Acabado	Dimensión	Material	Temperatura de color	PREZZO IVA escl.
LM4228	350	3	Blanco	40X25H mm	Aluminio / PC	6000 K	8,50
LM4230	350	3	Blanco	40X25H mm	Aluminio / PC	3000 K	8,50

conf. scatol.

5 pz	100 pz	IP20	30000 H	AC 85 265V	36°	CRI 80	F.P 0.5	Corte 30 mm
------	--------	------	---------	------------	-----	--------	---------	-------------

Iluminación Interior / Downlight LED

M Downlight LED Road



GARANTÍA 3 AÑOS



Ref	Lm	Vatios	Acabado	Dimensión	Material	Temperatura de color	PREZZO IVA escl.
LM4281	500	7	Blanco	85X40H mm	Aluminio / PC	6000 K	10,30
LM4282	500	7	Blanco	85X40H mm	Aluminio / PC	4500 K	10,30
LM4283*	500	7	Blanco	85X40H mm	Aluminio / PC	3000 K	10,30

conf. scatol.

1 pz	50 pz	IP54	30000 H	AC 165 265V	36°	CRI 80	Corte 72 mm
------	-------	------	---------	-------------	-----	--------	-------------

*ordinabili

PACK 3

Accesorios



Negro
LM4286
PREZZO IVA escl. 6,80

Dorado
LM4287
PREZZO IVA escl. 6,80

Plata
LM4285
PREZZO IVA escl. 6,80

conf.	scatol.
3 pz	200 pz

Iluminación Interior / Downlight LED

M Downlight LED Cobfix



Ref	Lm	Vatios	Acabado	Corte	Dimensión	Material	Temperatura de color	PREZZO IVA escl.
GA4405	900	10	Blanco	75 mm	85X50H mm	Aluminio	4500 K	15,60
GA4406*	900	10	Blanco	75 mm	85X50H mm	Aluminio	3000 K	15,60
GA4408	1350	15	Blanco	90 mm	105X53H mm	Aluminio	4500 K	20,90
GA4409*	1350	15	Blanco	90 mm	105X53H mm	Aluminio	3000 K	20,90
GA4411	1800	20	Blanco	115 mm	135X53H mm	Aluminio	4500 K	29,90
GA4412*	1800	20	Blanco	115 mm	135X53H mm	Aluminio	3000 K	29,90

Accesorios

Driver Triac
LF-GDE014YG



conf. scatol.

1 pz	60 pz	IP20	30000 H	AC 170 265V	36°	CRI 80
------	-------	------	---------	-------------	-----	--------

Iluminación Interior / Downlight LED

M Downlight LED Cobmon



Ref	Lm	Vatios	Acabado	Dimensión	Material	Temperatura de color	PREZZO IVA escl.
LM4171	560	7	Blanco	82X45H mm	Aluminio	6000 K	9,90
LM4172	560	7	Blanco	82X45H mm	Aluminio	4500 K	9,90
LM4173*	560	7	Blanco	82X45H mm	Aluminio	3000 K	9,90

conf. scatol.

1 pz	50 pz	IP20	30000 H	AC 170 265V	24°	CRI 90	F.P 0.6
------	-------	------	---------	-------------	-----	--------	---------

Iluminación Interior / Downlight LED

M Panel LED Circular Serie Pro



*ordinabili



Ref	Lm	Vatios	Acabado	Dimensión	Material	Temperatura de color	PREZZO IVA escl.
GA5610	2000	20	Blanco	220X10H mm	Aluminio	6000 K	18,00
GA5611	2000	20	Blanco	220X10H mm	Aluminio	4000 K	18,00
GA5612*	2000	20	Blanco	220X10H mm	Aluminio	3000 K	18,00

Accesorios

Driver Dali
LF-GSD030PF
Kit conversión
LF-GSP012YG



conf. scatol.

1 pz	20 pz	IP20	30000 H	AC 170 265V	120°	CRI 80	F.P 0.50	4 Kv	Corte 200 mm	Salida DC25-40V	Int Corriente 450 mA
------	-------	------	---------	-------------	------	--------	----------	------	--------------	-----------------	----------------------

Lifud es un fabricante de controladores LED. Por lo tanto, un "driver Lifud" se refiere a un controlador LED producido por esta marca específica.

Los controladores LED son componentes electrónicos que se utilizan para controlar el flujo de energía eléctrica y la intensidad de la luz emitida por las lámparas LED.

El controlador LED Lifud, en particular, se utiliza generalmente en luminarias LED de **alta calidad** debido a su **confiabilidad, alta eficiencia y larga**

vida útil. La empresa Lifud se especializa en la fabricación de controladores LED para todo tipo de luminarias LED.

La compañía ofrece una amplia gama de productos que incluyen controladores LED para iluminación **comercial, residencial, industrial, de paisajes y otros usos.**

Además de su **calidad y fiabilidad**, los controladores LED de Lifud se caracterizan por su **alta eficiencia energética y larga vida útil.**

La empresa se dedica a la innovación y el diseño constantes de nuevos productos y tecnologías para satisfacer las necesidades del mercado en constante evolución de la iluminación LED.

LIFUD[®]

Illuminación Interior / Downlight LED

M Panel LED Circular Serie Slim



GARANTÍA 3 AÑOS



Ref	Lm	Vatios	Acabado	Corte	Dimensión	Material	Temperatura de color	PREZZO IVA escl.
LM5560	500	5	Blanco	70 mm	85X10H mm	Aluminio	6000 K	5,20
LM5561	500	5	Blanco	70 mm	85X10H mm	Aluminio	4500 K	5,20
LM5562*	500	5	Blanco	70 mm	85X10H mm	Aluminio	3000 K	5,20
LM5201	600	6	Blanco	105 mm	120X19H mm	Aluminio	6000 K	5,60
LM5202	600	6	Blanco	105 mm	120X19H mm	Aluminio	4500 K	5,60
LM5203*	600	6	Blanco	105 mm	120X19H mm	Aluminio	3000 K	5,60
LM5504	900	9	Blanco	135 mm	145X20H mm	Aluminio	6000 K	7,20
LM5505	900	9	Blanco	135 mm	145X20H mm	Aluminio	4500 K	7,20
LM5506*	900	9	Blanco	135 mm	145X20H mm	Aluminio	3000 K	7,20
LM5207	1200	12	Blanco	150 mm	170X10H mm	Aluminio	6000 K	8,00
LM5208	1200	12	Blanco	150 mm	170X10H mm	Aluminio	4500 K	8,00
LM5209*	1200	12	Blanco	150 mm	170X10H mm	Aluminio	3000 K	8,00
LM5210	2000	20	Blanco	200 mm	220X10H mm	Aluminio	6000 K	9,80
LM5211	2000	20	Blanco	200 mm	220X10H mm	Aluminio	4500 K	9,80
LM5212*	2000	20	Blanco	200 mm	220X10H mm	Aluminio	3000 K	9,80
LM5213	2500	25	Blanco	280 mm	295X20H mm	Aluminio	6000 K	17,60
LM5214	2500	25	Blanco	280 mm	295X20H mm	Aluminio	4500 K	17,60
LM5215*	2500	25	Blanco	280 mm	295X20H mm	Aluminio	3000 K	17,60

conf. scatol.

1 pz	20 pz	IP20	30000 H	AC 170 265V	120°	- 20°C + 45°C	CRI 80
------	-------	------	---------	-------------	------	---------------	--------

Illuminación Interior / Downlight LED

M Panel LED Cuadrado Serie Slim



GARANTÍA 3 AÑOS



Ref	Lm	Vatios	Acabado	Corte	Dimensión	Material	Temperatura de color	PREZZO IVA escl.
LM5220	600	6	Blanco	105X105 mm	117X10H mm	Aluminio	6000 K	6,00
LM5221	600	6	Blanco	105X105 mm	117X10H mm	Aluminio	4500 K	6,00
LM5222	600	6	Blanco	105X105 mm	117X10H mm	Aluminio	3000 K	6,00
LM5226	1200	12	Blanco	155X155 mm	170X20H mm	Aluminio	6000 K	8,50
LM5227	1200	12	Blanco	155X155 mm	170X20H mm	Aluminio	4500 K	8,50
LM5228	1200	12	Blanco	155X155 mm	170X20H mm	Aluminio	3000 K	8,50
LM5229	2000	20	Blanco	205X205 mm	220X20H mm	Aluminio	6000 K	9,90
LM5230	2000	20	Blanco	205X205 mm	220X20H mm	Aluminio	4500 K	9,90
LM5231	2000	20	Blanco	205X205 mm	220X20H mm	Aluminio	3000 K	9,90
LM5232	2500	25	Blanco	285X285 mm	117X10H mm	Aluminio	6000 K	18,90
LM5233	2500	25	Blanco	285X285 mm	117X10H mm	Aluminio	4500 K	18,90
LM5234	2500	25	Blanco	285X285 mm	117X10H mm	Aluminio	3000 K	18,90

conf. scatol.

1 pz	20 pz	IP20	30000 H	AC 170 265V	120°	- 20°C + 45°C	CRI 80
------	-------	------	---------	-------------	------	---------------	--------

Iluminación Interior / Downlight LED

M Panel LED Circular Níquel CCT



GARANTÍA
3 AÑOS



Ref	Lm	Vatios	Acabado	Corte	Dimensión	Material	Temperatura de color	PREZZO IVA escl.
LM5501	600	6	Níquel	110 mm	120X30H mm	Aluminio	CCT	10,50
LM5507	1200	12	Níquel	150 mm	170X20H mm	Aluminio	CCT	14,50
LM5520	2000	20	Níquel	205 mm	225X20H mm	Aluminio	CCT	21,50
LM5523	2500	25	Níquel	280 mm	295X20H mm	Aluminio	CCT	27,60

conf. scatol.

1 pz	20 pz	IP44	30000 H	AC 170 265V	120°	- 20°C + 45°C	CRI 80
------	-------	------	---------	-------------	------	------------------	--------

Iluminación Interior / Downlight LED

M Panel LED Circular Níquel CCT



GARANTÍA
3 AÑOS



Ref	Lm	Vatios	Acabado	Corte	Dimensión	Material	Temperatura de color	PREZZO IVA escl.
LM5508	1200	12	Níquel	155X155 mm	172X20H mm	Aluminio	CCT	16,30
LM5521	2000	20	Níquel	205X205 mm	225X20H mm	Aluminio	CCT	20,80
LM5524	2500	25	Níquel	285X285 mm	290X10H mm	Aluminio	CCT	32,40

conf. scatol.

1 pz	20 pz	IP44	30000 H	AC 170 265V	120°	- 20°C + 45°C	CRI 80
------	-------	------	---------	-------------	------	------------------	--------

Iluminación Interior / Plafones LED

M Panel de Superficie Serie Slim



GARANTÍA
3 AÑOS



Ref	Lm	Vatios	Acabado	Dimensión	Material	Temperatura de color	PREZZO IVA escl.
LM5564	500	5	Blanco	80X32H mm	Aluminio	6000K	7,25
LM5565	500	5	Blanco	80X32H mm	Aluminio	4500K	7,25
LM5566*	500	5	Blanco	80X32H mm	Aluminio	3000K	7,25
LM5289	600	6	Blanco	110X28H mm	Aluminio	6000K	7,40
LM5290	600	6	Blanco	110X28H mm	Aluminio	4500K	7,40
LM5291*	600	6	Blanco	110X28H mm	Aluminio	3000K	7,40
LM5240	1200	12	Blanco	170X28H mm	Aluminio	6000K	9,70
LM5241	1200	12	Blanco	170X28H mm	Aluminio	4500K	9,70
LM5242*	1200	12	Blanco	170X28H mm	Aluminio	3000K	9,70
LM5243	2000	20	Blanco	210X28H mm	Aluminio	6000K	12,30
LM5244	2000	20	Blanco	210X28H mm	Aluminio	4500K	12,30
LM5245*	2000	20	Blanco	210X28H mm	Aluminio	3000K	12,30
LM5246	2500	25	Blanco	285X28H mm	Aluminio	6000K	20,50
LM5247	2500	25	Blanco	285X28H mm	Aluminio	4500K	20,50
LM5248*	2500	25	Blanco	285X28H mm	Aluminio	3000K	20,50
LM5291	2500	25	Blanco	285X28H mm	Aluminio	3000K	ND

1 pz	20 pz	IP20	30000 H	- 20°C + 45°C	AC 170 265V	120°	CRI 80
------	-------	------	---------	------------------	-------------	------	--------

*ordinabili

conf. scatol.

Iluminación Interior / Plafones LED

M Panel de Superficie Serie Pro Circular



Ref	Lm	Vatios	Acabado	Dimensión	Material	Temperatura de color	PREZIO IVA escl.
GA5643	2000	20	Blanco	225X20H mm	Aluminio	6000 K	ND
GA5644	2000	20	Blanco	225X20H mm	Aluminio	4000 K	ND
GA5645	2000	20	Blanco	225X20H mm	Aluminio	3000 K	ND

Accesorios



Driver Dali
LF-GSD030PF
Kit conversión
LF-GSP012YG

IP20	30000 H	AC 170 265V	120°	- 20°C + 45°C	CRI 80	F.P 0.50	IK 5	4Kv	Salida DC25-40V	Int corriente 450mA
------	---------	-------------	------	---------------	--------	----------	------	-----	-----------------	---------------------

Iluminación Interior / Plafones LED

M Panel de Superficie Serie Slim Cuadrado



Ref	Lm	Vatios	Acabado	Dimensión	Material	Temperatura de color	PREZIO IVA escl.
LM5250	1200	12	Blanco	170X28H mm	Aluminio	6000K	9,50
LM5251	1200	12	Blanco	170X28H mm	Aluminio	4500K	9,50
LM5252*	1200	12	Blanco	170X28H mm	Aluminio	3000K	9,50
LM5253	2000	20	Blanco	225X27H mm	Aluminio	6000K	11,80
LM5254	2000	20	Blanco	225X27H mm	Aluminio	4500K	11,80
LM5255*	2000	20	Blanco	225X27H mm	Aluminio	3000K	11,80
LM5256	2500	25	Blanco	285X40H mm	Aluminio	6000K	20,40
LM5257	2500	25	Blanco	285X40H mm	Aluminio	4500K	20,40
LM5258*	2500	25	Blanco	285X40H mm	Aluminio	3000K	20,40

1 pz	20 pz	IP20	30000 H	- 20°C + 45°C	AC 170 265V	120°	CRI 80
------	-------	------	---------	---------------	-------------	------	--------

conf. scatol.

Iluminación Interior / Plafones LED

M Panel de Superficie Níquel Circular CCT



Ref	Lm	Vatios	Acabado	Dimensión	Material	Temperatura de color	PREZIO IVA escl.
LM5537	600	6	Níquel	120X35H mm	Aluminio	CCT	12,65
LM5540	1200	12	Níquel	170X40H mm	Aluminio	CCT	19,20
LM5543	2000	20	Níquel	225X32H mm	Aluminio	CCT	22,90
LM5546	2500	25	Níquel	300X35H mm	Aluminio	CCT	34,70

1 pz	20 pz	IP44	30000 H	- 20°C + 45°C	AC 170 265V	120°	CRI 80
------	-------	------	---------	---------------	-------------	------	--------

*ordinabili

Iluminación Interior / Plafones LED

M Panel de Superficie Niquel Cuadrado CCT



GARANTÍA
3 AÑOS



Ref	Lm	Vatios	Acabado	Dimensión	Material	Temperatura de color	PREZZO IVA escl.
LM5541	1200	12	Niquel	170X170X35H mm	Aluminio	CCT	18,00
LM5544	2000	20	Niquel	225X225X35H mm	Aluminio	CCT	25,90
LM5547	2500	25	Niquel	300X300X35H mm	Aluminio	CCT	37,90

1 pz	20 pz	IP44	30000 H	- 20°C + 45°C	AC 170 265V	120°	CRI 80
------	-------	------	---------	------------------	----------------	------	-----------

conf. scatol.

Iluminación Interior / Downlight LED

M Downlight LED Lass 22W



GARANTÍA
5 AÑOS



Ref	Lm	Vatios	Acabado	Dimensión	Material	Temperatura de color	PREZZO IVA escl.
GA5293*	2200	22	Blanco	220X30H mm	Aluminio	6000 K	28,90
GA5294*	2200	22	Blanco	220X30H mm	Aluminio	4500 K	28,90
GA5295*	2200	22	Blanco	220X30H mm	Aluminio	3000 K	28,90

Accesorios

conf.	scatol.								
1 pz	20 pz	IP20	30000 H	AC 220 240V	120°	CRI 80	F.P 0.6	UGR 19	Corte 180 mm

Iluminación Interior / Downlight LED

M Downlight LED Lass 32W



GARANTÍA
3 AÑOS



Ref	Lm	Vatios	Acabado	Dimensión	Material	Temperatura de color	PREZZO IVA escl.
LM5353	3200	32	Blanco	220X30H mm	Aluminio	6000 K	30,90
LM5354	3200	32	Blanco	220X30H mm	Aluminio	4500 K	30,90
LM5355*	3200	32	Blanco	220X30H mm	Aluminio	3000 K	30,90

Accesorios

conf.	scatol.							
1 pz	20 pz	IP20	30000 H	AC 85 265V	120°	CRI 80	F.P 0.96	Corte 180 mm

Iluminación Interior / Downlight LED

M Downlight LED Lass 50W



GARANTÍA
3 AÑOS



Ref	Lm	Vatios	Acabado	Dimensión	Material	Temperatura de color	PREZZO IVA escl.
LM5356	5000	50	Blanco	225X40H mm	Aluminio	6000 K	44,00
LM5357	5000	50	Blanco	225X40H mm	Aluminio	4500 K	44,00

conf. scatol.

1 pz	20 pz	IP20	30000 H	AC 85 265V	120°	CRI 80	F.P 0.96	Corte 185 mm
------	-------	------	---------	---------------	------	-----------	-------------	-----------------

*ordinabili

Iluminación Interior / Plafones LED

M Plafon LED Circular Sense



GARANTÍA
3 AÑOS



Ref	Lm	Vatios	Acabado	Dimensión	Material	Temperatura de color	PREZZO IVAescl.
LM8251	1500	15	Blanco	230X45H mm	Aluminio / PC	6000 K	15,90
LM8252	1500	15	Blanco	230X45H mm	Aluminio / PC	4500 K	15,90
LM8254	3000	30	Blanco	300X50H mm	Aluminio / PC	6000 K	20,65
LM8255	3000	30	Blanco	300X50H mm	Aluminio / PC	4500 K	20,65
LM8257	4000	40	Blanco	385X48H mm	Aluminio / PC	6000 K	27,80
LM8258	4000	40	Blanco	385X48H mm	Aluminio / PC	4500 K	27,80
LM8260	5000	50	Blanco	480X68H mm	Aluminio / PC	6000 K	48,80
LM8261	5000	50	Blanco	480X68H mm	Aluminio / PC	4500 K	48,80

1 pz 1 pz IP44 30000 H AC 180 260V 120° CRI 80
 conf. scatol.



Plafón LED de superficie Circular acabado en blanco y con una protección de IP44.

De diseño arquitectónico y actual, buscando la naturalidad y sencillez.

Esta basada en tecnología SMD-LED integrando diodos LED de alta luminosidad e eficiencia, permitiendo tamaños reducidos y confort visual.

Perfecto para sustituir plafones de incandescencia o ahorro de energía.

Lleva una pieza para fijar en el techo y posteriormente poder unir el plafón, consiguiendo así una protección más alta de los LED del interior del plafón.



Iluminación Interior / Downlight LED

M Downlight LED Luxtar



GARANTÍA 3 AÑOS



Ref	Lm	Vatios	Acabado	Corte	Dimensión	Material	Temperatura de color	PREZZO IVA escl.
LM4260	1200	15	Blanco	100 mm	115X50H mm	Aluminio	6000 K	21,00
LM4261	1200	15	Blanco	100 mm	115X50H mm	Aluminio	4500 K	21,00
LM4266*	1200	15	Blanco	100 mm	115X50H mm	Aluminio	3000 K	21,00
LM4262	2400	30	Blanco	145 mm	160X55H mm	Aluminio	6000 K	30,90
LM4263	2400	30	Blanco	145 mm	160X55H mm	Aluminio	4500 K	30,90
LM4267*	2400	30	Blanco	145 mm	160X55H mm	Aluminio	3000 K	30,90
LM4264	4000	50	Blanco	200 mm	215X65H mm	Aluminio	6000 K	40,90
LM4265	4000	50	Blanco	200 mm	215X65H mm	Aluminio	4500 K	40,90
LM4268*	4000	50	Blanco	200 mm	215X65H mm	Aluminio	3000 K	40,90

conf. scatol.

1 pz	20 pz	IP20	30000 H	AC 170 265V	90°	CRI 80	F.P 0.90	UGR 19
------	-------	------	---------	-------------	-----	--------	----------	--------

Iluminación Interior / Plafones LED

M Plafón LED Halls con Sensor Movimiento



GARANTÍA 3 AÑOS



Ref	Lm	Vatios	Acabado	Dimensión	Material	Temperatura de color	PREZZO IVA escl.
LM8219	1200	15	Blanco	240X70H mm	Aluminio / PC	6000 K	39,40
LM8220	1200	15	Blanco	240X70H mm	Aluminio / PC	4500 K	39,40
LM8221	1600	20	Blanco	293X70H mm	Aluminio / PC	6000 K	47,90
LM8222	1600	20	Blanco	293X70H mm	Aluminio / PC	4500 K	47,90
LM8223*	1600	20	Blanco	293X70H mm	Aluminio / PC	3000 K	47,90

conf. scatol.

1 pz	1 pz	IP20	30000 H	AC 170 265V	120°	CRI 80	Detección 360°	Detección 6m	Tiempo Max-min 10seg 2min	Modo Día noche
------	------	------	---------	-------------	------	--------	----------------	--------------	---------------------------	----------------

*ordinabili

Plafón LED de superficie Circular acabado en blanco y con una protección de IP20.

Diodos LED Epistar de alta luminosidad e eficiencia.

Perfecto para sustituir plafones de incandescencia o ahorro de energía.



REGULACIÓN DE TIEMPO

Posibilidad de regular el tiempo max - min, con esta función puede decidir el tiempo máximo (2 minutos) y el mínimo 10 segundos.



REGULACIÓN DE SENSIBILIDAD

Posibilidad de regular la sensibilidad a la luz solar, con esta función puede determinar el nivel de falta de luz solar a la que desea que el detector se active.



Iluminación Interior / Plafones LED

M Plafón Sensor Movimiento Nantes



GARANTÍA
3 AÑOS



Ref	Fuente Lum.	Acabado	Dimensión	Material	PREZZO IVAescl.
LM6608	2XE27	Blanco	320X100H mm	Aluminio / PC	32,90

conf. scatol.

1 pz	10 pz	IP20	AC 100 240V	120°	CRI 80	Detección 360°	Detección 6m	Tiempo Max-min 20 seg 40 seg	Modo Día noche
------	-------	------	----------------	------	-----------	-------------------	-----------------	---------------------------------------	----------------------

20S-40S

Posibilidad de regular el tiempo max - min, con esta función puede decidir el tiempo máximo (40 segundos) o el mínimo (20 segundos).



MODO DÍA

Al recibir el sensor luz el plafón automáticamente deja de funcionar



MODO NOCHE

Al dejar de recibir el sensor luz el plafón automáticamente comienza a funcionar



Iluminación Interior / Plafones LED

M Plafón Sensor Movimiento Turin

INCLUYE
CONTROL
REMOTO



GARANTÍA
3 AÑOS



Ref	Lm	Vatios	Acabado	Dimensión	Material	Temperatura de color	PREZZO IVAescl.
LM8231	3600	40	Blanco	400X90H mm	PC	CCT	63,90

conf. scatol.

1 pz	10 pz	IP20	30000 H	AC 170 265V	180°	CRI 80
------	-------	------	---------	----------------	------	-----------

Iluminación Interior / Plafones LED

M Plafon LED Circular Bari CCT



Ref	Lm	Vatios	Acabado	Dimensión	Material	Temperatura de color	PREZZO IVA escl.
LM8232	3600	40	Blanco	400X90H mm	PC	CCT	58,90

conf. scatol.

1 pz	10 pz	IP20	30000 H	AC 170 265V	180°	CRI 80
------	-------	------	---------	-------------	------	--------

Iluminación Interior / Plafones LED

M Plafon LED Circular Remo CCT



Ref	Lm	Vatios	Acabado	Dimensión	Material	Temperatura de color	PREZZO IVA escl.
LM8234	3600	40	Blanco	385X75H mm	PC	CCT	62,90

conf. scatol.

1 pz	10 pz	IP20	30000 H	AC 170 265V	180°	CRI 80
------	-------	------	---------	-------------	------	--------

Iluminación Interior / Plafones LED

M Plafon LED Circular Dial



Ref	Lm	Vatios	Acabado	Dimensión	Material	Temperatura de color	PREZZO IVA escl.
LM8201	3000	36	Blanco	390X65H mm	PC	6000 K	32,90
LM8202	3000	36	Blanco	390X65H mm	PC	4500 K	32,90
LM8204	2000	24	Blanco	340X65H mm	PC	6000 K	28,90
LM8205	2000	24	Blanco	340X65H mm	PC	4500 K	28,90

conf. scatol.

1 pz	10 pz	IP20	30000 H	AC 170 265V	180°	CRI 80
------	-------	------	---------	-------------	------	--------

Iluminación Interior / Plafones LED

M Plafon LED Circular Ice



Ref	Lm	Vatios	Acabado	Dimensión	Material	Temperatura de color	PREZZO IVA escl.
LM8210	2000	24	Blanco	340X65H mm	PC	6000 K	28,90
LM8211	2000	24	Blanco	340X65H mm	PC	4500 K	28,90
LM8207	3000	36	Blanco	390X65H mm	PC	6000 K	32,90
LM8208	3000	36	Blanco	390X65H mm	PC	4500 K	32,90

conf. scatol.

1 pz	10 pz	IP20	30000 H	AC 170 265V	180°	CRI 80
------	-------	------	---------	-------------	------	--------

Iluminación Interior / Plafones LED

M Plafón LED Magic Rgb+CCT

INCLUYE CONTROL REMOTO

LED SMD5050

GARANTÍA 3 AÑOS

Ref	Lm	Vatios	Acabado	Dimensión	Material	Temperatura de color	PREZOO IVA escl.
LM6609	3600	36	Blanco	400X90H mm	Aluminio / PC	RGB+CCT	101,90
LM6619	3600	30	Blanco	400X90H mm	Aluminio / PC	RGB+CCT	77,80



conf. scatol.

1 pz	1 pz	IP20	25000 H	AC 170 265V	180°	CRI 80
------	------	------	---------	-------------	------	--------



La aplicación móvil **iLink** es una plataforma desarrollada por la empresa **Lifud** para controlar y programar los controladores LED a través de dispositivos móviles.

Esta aplicación se usa para configurar, controlar y monitorear la iluminación LED en tiempo real, lo que es útil para cualquier cosa, desde la gestión de iluminación residencial hasta control de iluminación de grandes espacios comerciales.

Al descargar la aplicación **iLink** en tu dispositivo móvil, puedes utilizarla para controlar de forma inalámbrica la iluminación LED compatible con el controlador **Lifud**, ajustando la intensidad de la luz, estableciendo horarios de encendido y apagado, creando ambientes personalizados y mucho más.

iLink es una aplicación útil para aquellos que deseen mejorar su experiencia con controladores LED, aportando comodidad y flexibilidad al control de la generación de luz.

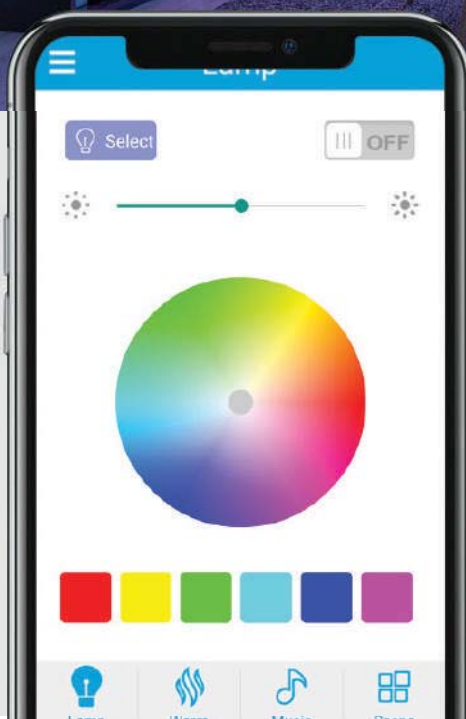

La aplicación permite a los usuarios ajustar la temperatura de color, la intensidad de luz y el encendido y apagado de los paneles LED.

También permite crear y guardar ajustes de luz personalizados para diferentes situaciones, como luz de lectura, luz de trabajo, luz de relajación, etc.

Además, los usuarios pueden configurar horarios para sus paneles LED, lo que les permite encender y apagar automáticamente en momentos específicos del día.

En general, la aplicación **iLink** para paneles LED mejora en gran medida la experiencia del usuario con sus paneles LED al hacer que sea fácil y conveniente controlar sus ajustes y configuraciones de luz mediante un dispositivo móvil.

Iluminación Interior / Paneles LED

M Panel LED Serie Trielle 60W



GARANTÍA 3 AÑOS



Ref	Lm	Vatios	Acabado	Dimensión	Material	Temperatura de color	PREZZO IVA escl.
LM5317	6000	60	Blanco	595X595X35H mm	Aluminio	6000K	49,60
LM5318	6000	60	Blanco	595X595X35H mm	Aluminio	4500K	49,60

conf. scatol.

2 pz	8 pz	IP40	30000 H	AC 170 265V	120°	- 20°C + 45°C	CRI 80	F.P 0.95	UGR 19
------	------	------	---------	-------------	------	---------------	--------	----------	--------

Iluminación Interior / Paneles LED

M Panel LED Serie Trielle 42W



GARANTÍA 3 AÑOS



Ref	Lm	Vatios	Acabado	Dimensión	Material	Temperatura de color	PREZZO IVA escl.
LM5314	4200	42	Blanco	595X595X35H mm	Aluminio	6000K	36,90
LM5315	4200	42	Blanco	595X595X35H mm	Aluminio	4500K	36,90

Accesorios



Driver Dali Lf-Gsd040Pf
Driver Philips LM2284
Kit conversión Driver 0-10v
LF-GSP012YG Lf Aaa040B1050-42

conf. scatol.

2 pz	8 pz	IP40	30000 H	AC 170 265V	120°	- 20°C + 45°C	CRI 80	F.P 0.95	UGR 19
------	------	------	---------	-------------	------	---------------	--------	----------	--------

Iluminación Interior / Paneles LED

M Panel LED Serie Trielle 48W UGR17



GARANTÍA 5 AÑOS



Ref	Lm	Vatios	Acabado	Dimensión	Material	Temperatura de color	PREZZO IVA escl.
LM5305*	4800	48	Blanco	595X595X35H mm	Aluminio / PC	6000 K	57,50
LM5306*	4800	48	Blanco	595X595X35H mm	Aluminio / PC	4500 K	57,50
LM5307*	4800	48	Blanco	595X595X35H mm	Aluminio / PC	3000 K	57,50

Accesorios



Kit conversión LF-GSP012YG

conf. scatol.

1 pz	6 pz	IP40	50000 H	AC 170 265V	120°	- 20°C + 45°C	CRI 80	F.P 0.95	UGR 17
------	------	------	---------	-------------	------	---------------	--------	----------	--------

Iluminación Interior / Paneles LED

M Panel LED Rectangular Serie Bure 24W



GARANTÍA 3 AÑOS



Ref	Lm	Vatios	Acabado	Dimensión	Material	Temperatura de color	PREZZO IVA escl.
LM5321*	2400	24	Blanco	592X295X23H mm	Aluminio	6000 K	35,90
LM5322*	2400	24	Blanco	592X295X23H mm	Aluminio	4500 K	35,90

conf. scatol.

2 pz	10 pz	IP40	30000 H	AC 170 265V	120°	CRI 80	F.P 0.95	UGR 19
------	-------	------	---------	-------------	------	--------	----------	--------

*ordinabili

Iluminación Interior / Paneles LED

M Panel LED Rectangular Serie Bure 40W



GARANTÍA 5 AÑOS



Ref	Lm	Vatios	Acabado	Dimensión	Material	Temperatura de color	PREZZO IVA escl.
LM5267	4000	40	Blanco	1195X295X30H mm	Aluminio	CCT	66,90

Accesorios



Driver Dali Lf-Gsd040Pf
Kit conversión LF-GSP012YG
Driver Philips LM2284
Driver 0-10v Lf Aaa040B1050-42

conf. scatol.

1 pz	6 pz	IP40	30000 H	AC 170 265V	120°	CRI 80	F.P 0.95	UGR 19
------	------	------	---------	-------------	------	--------	----------	--------

Iluminación Interior / Paneles LED

M Panel LED Rectangular Serie Bure



GARANTÍA 5 AÑOS



Ref	Lm	Vatios	Acabado	Dimensión	Material	Temperatura de color	PREZZO IVA escl.
LM5268	6500	80	Blanco	1195X595X30H mm	Aluminio	6000 K	116,90
LM5269	6500	80	Blanco	1195X595X30H mm	Aluminio	4500 K	116,90

Accesorios



Driver Dali Lf-Gsd040Pf
Kit conversión LF-GSP012YG
Driver Philips LM2284
Driver 0-10v Lf Aaa040B1050-42

1 pz	4 pz	IP40	30000 H	AC 170 265V	120°	CRI 80	F.P 0.90	UGR 19
------	------	------	---------	-------------	------	--------	----------	--------

conf. scatol.

Iluminación Interior / Paneles LED

M Panel LED de Superficie Rectangular Serie Home



GARANTÍA 3 AÑOS



Ref	Lm	Vatios	Acabado	Dimensión	Material	Temperatura de color	PREZZO IVA escl.
LM5323	2400	24	Blanco	595X295X38H mm	Aluminio	CCT	41,90

conf. scatol.

1 pz	8 pz	IP40	30000 H	AC 170 265V	120°	- 20°C + 45°C	CRI 80	F.P 0.95
------	------	------	---------	-------------	------	---------------	--------	----------

Iluminación Interior / Paneles LED

M Panel LED de Marco Luminoso

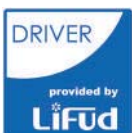

GARANTÍA 3 AÑOS



Ref	Lm	Vatios	Acabado	Dimensión	Material	Temperatura de color	PREZZO IVA escl.
LM5329	4200	42	Blanco	590X590 mm	Aluminio	6000 K	36,90
LM5330	4200	42	Blanco	590X590 mm	Aluminio	4500 K	36,90

Accesorios



Driver Dali Lf-Gsd040Pf
Kit conversión LF-GSP012YG
Driver Philips LM2284
Driver 0-10v Lf Aaa040B1050-42

2 pz	16 pz	IP20	30000 H	AC 170 265V	120°	CRI 80	F.P 0.95
------	-------	------	---------	-------------	------	--------	----------

Iluminación Interior / Aros y Accesorios / Paneles LED

M Kit de superficie de Panel Blanco

GARANTÍA
3 AÑOS



Ref	Acabado	Dimensión	Material	PREZZO IVA escl.
LM9032	Blanco	1200X600X50H mm	Aluminio	22,60
LM9034	Blanco	1200X300X50H mm	Aluminio	27,90
LM9036	Blanco	1200X600X50H mm	Aluminio	30,90
LM9037	Blanco	600X300X50H mm	Aluminio	18,50

conf. scatola.

1 pz 30 pz IP20

Iluminación Interior / Aros y Accesorios / Paneles LED

M Marco de empotrar de Panel LED

GARANTÍA
3 AÑOS



Ref	Corte	Acabado	Dimensión	Material	PREZZO IVA escl.
LM9035	602X602 mm	Blanco	625X625 mm	Aluminio	24,20
LM9039	602X602 mm	Blanco	625X625 mm	Aluminio	27,90
LM9045	1202X302 mm	Blanco	1225X325 mm	Aluminio	28,00
LM9046	1225X625 mm	Blanco	1225X625 mm	Aluminio	43,50

conf. scatola.

1 pz 10 pz IP20

Iluminación Interior / Tubos LED

M Tubo LED T8 Stak Cristal Conexión Un Lateral

INCLUYE
LED
STARTER



GARANTÍA
3 AÑOS



Ref	Lm	Vatios	Acabado	Dimensión	Material	Temperatura de color	PREZZO IVA escl.
LM1056	900	9	Opal	600X30 mm	Cristal	6000 K	5,55
LM1059	900	9	Opal	600X30 mm	Cristal	4500 K	5,55
LM1068	1200	12	Opal	900X30 mm	Cristal	6000 K	5,80
LM1057	1800	18	Opal	1200X30 mm	Cristal	6000 K	6,00
LM1063	1800	18	Opal	1200X30 mm	Cristal	4500 K	6,00
LM1058	2400	24	Opal	1500X30 mm	Cristal	6000 K	8,40
LM1064	2400	24	Opal	1500X30 mm	Cristal	4500 K	8,40

1 pz 20 pz IP20 30000 H AC 170 265V 300° CRI 80

conf. scatola.

Iluminación Interior / Tubos LED

M Tubo de LED T8 Ekran



GARANTÍA
3 AÑOS



Ref	Lm	Vatios	Acabado	Conexión	Dimensión	Material	Temperatura de color	PREZZO IVA escl.
LM1001*	1000	10	Opal	1 Lateral	600X30 mm	Aluminio	6000 K	ND
LM1010*	2000	20	Opal	1 Lateral	1200X30 mm	Aluminio	6000 K	ND
LM1012*	2000	20	Opal	1 Lateral	1200X30 mm	Aluminio	4500 K	ND
LM1016*	2400	24	Opal	1 Lateral	1500X30 mm	Aluminio	6000 K	ND
LM1018*	2400	24	Opal	1 Lateral	1500X30 mm	Aluminio	4500 K	ND

1 pz 25 pz IP42 30000 H AC 85 265V 120° CRI 80 F.P 0.95

conf. scatola.

*ordinabili

Illuminación Interior / Tubos LED

M Tubo de LED T8 Conexión Un Lateral



GARANTÍA
3 AÑOS



Ref	Vatios	Acabado	Dimensión	Material	Temperatura de color	PREZZO IVA escl.
LM1053	17	Opal	1200X30 mm	Aluminio	Verde	14,50
LM1054	17	Opal	1200X30 mm	Aluminio	Azul	14,50
LM1055	17	Opal	1200X30 mm	Aluminio	Rosa	14,50

conf. scatol.

1 pz	1 pz	IP42	30000 H	AC 85 265V	120°	CRI 80
------	------	------	---------	------------	------	--------

Illuminación Interior / Tubos LED

M Tubo de LED T8 Ekran Con detector de Movimiento il.Seguridad



GARANTÍA
3 AÑOS



Ref	Lm	Vatios	Acabado	Conexión	Dimensión	Material	Temperatura de color	PREZZO IVA escl.
LM1007	2000	20	Opal	1 Lateral	1200X30 mm	Aluminio	6000 K	22,70
LM1009	2400	24	Opal	2 Laterales	1500X30 mm	Aluminio	6000 K	27,30

conf. scatol.

1 pz	20 pz	IP42	30000 H	AC 85 265V	120°	CRI 80	F.P 0.95
------	-------	------	---------	------------	------	--------	----------

Reducción al **20%** transcurridos
30/40 seg sin detectar movimiento

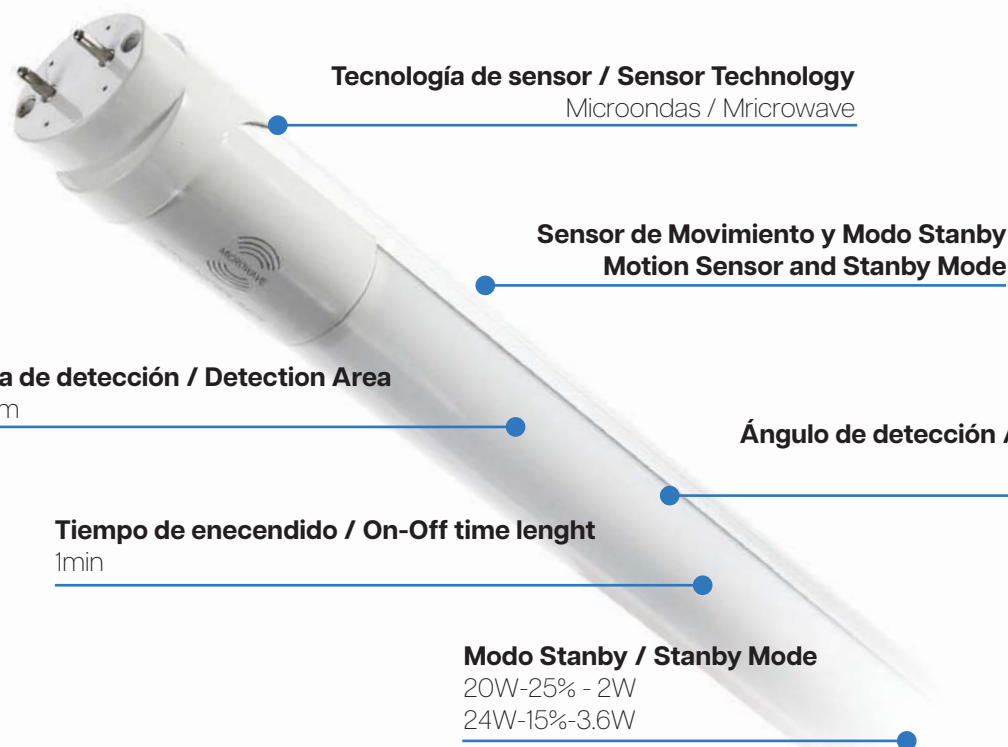

Iluminación Interior / Regletas LED / Pantallas LED

M Soporte para tubo LED Zaslon Conexión un lado

GARANTÍA
3 AÑOS



Ref	Acabado	Dimensión	Material	PREZZO IVA escl.
LM1021	Blanco	600 mm	Aluminio	4,20
LM1023	Blanco	1200 mm	Aluminio	5,40
LM1024	Blanco	1500 mm	Aluminio	7,40

conf. scatol.

1 pz

50 pz

Iluminación Interior / Pantallas LED

M Pantalla Estanca Platno para dos tubo LED

GARANTÍA
3 AÑOS



Ref	Tubos	Dimensión	Material	PREZZO IVA escl.
LM1026	1	1260X66X90H mm	PC	21,80
LM1027	1	1565X66X90H mm	PC	32,50
LM1028	2	1200X110X90H mm	PC	26,30
LM1029	2	1565X110X90H mm	PC	37,20

conf. scatol.

1 pz

8 pz

IP65

Iluminación Interior / Regletas LED

M Regleta LED SlimLine Fast



GARANTÍA
3 AÑOS



Ref	Lm	Vatios	Acabado	Dimensión	Material	Temperatura de color	PREZZO IVA escl.
LM1170	4000	40	Blanco	1200X75X30H mm	Aluminio / PC	6000 K	22,90
LM1171	4000	40	Blanco	1200X75X30H mm	Aluminio / PC	4500 K	22,90

conf. scatol.

1 pz

20 pz

IP20

50000 H

AC 170
265V

120°

CRI
85

Iluminación Interior / Regletas LED

M Regleta LED Slimline Moments



GARANTÍA
3 AÑOS



Ref	Lm	Vatios	Acabado	Dimensión	Material	Temperatura de color	PREZZO IVA escl.
LM1190	3500	40	Blanco	600X100X22H mm	Aluminio / PC	6000 K	26,90
LM1191	3500	40	Blanco	600X100X22H mm	Aluminio / PC	4500 K	26,90
LM1181	7600	90	Blanco	1200X100X26H mm	Aluminio / PC	6000 K	37,90
LM1182	7600	90	Blanco	1200X100X26H mm	Aluminio / PC	4500 K	37,90
LM1194	9300	110	Blanco	1500X100X22H mm	Aluminio / PC	6000 K	45,40

conf. scatol.

1 pz

20 pz

IP20

30000 H

AC 165
265V

120°

CRI
80

Iluminación Interior / Regletas LED

M Barra Lineal Trian



GARANTÍA
3 AÑOS



Ref	Lm	Vatios	Acabado	Dimensión	Material	Temperatura de color	PREZZO IVA escl.
LM1175	4000	40	Blanco	1200X55X45H mm	Aluminio / PC	6000 K	43,90
LM1176	4000	40	Blanco	1200X55X45H mm	Aluminio / PC	4500 K	43,90
LM1179	8000	80	Blanco	2400X55X45H mm	Aluminio / PC	6000 K	88,90
LM1180	8000	80	Blanco	2400X55X45H mm	Aluminio / PC	4500 K	88,90

conf. scatol.

1 pz	20 pz	IP20	30000 H	AC 85 265V	120°	CRI 80	Enlazable Max 10 UND
------	-------	------	---------	---------------	------	-----------	----------------------------



Iluminación Interior / Regletas LED

M Regleta LED SlimLine Garaz



GARANTÍA
3 AÑOS



Ref	Lm	Vatios	Acabado	Dimensión	Material	Temperatura de color	PREZZO IVA escl.
LM1075	2000	25	Gris	620X62X55H mm	Aluminio / PC	6000 K	26,80
LM1078	4000	50	Gris	1185X62X55H mm	Aluminio / PC	6000 K	32,90
LM1079	4800	60	Gris	1525X62X55H mm	Aluminio / PC	6000 K	35,90

conf. scatol.

1 pz	20 pz	IP65	30000 H	AC 85 265V	120°	- 20°C + 40°C	CRI 85	F.P 0.95	IK 5	Instalación Superficie
------	-------	------	---------	---------------	------	------------------	-----------	-------------	---------	---------------------------

Iluminación Interior / Pantallas LED
M Barra lineal Barcelona 40W



GARANTÍA
5 AÑOS

Ref	Lm	Vatios	Acabado	Dimensión	Material	Temperatura de color	PREZZO IVA esd.
LM1186	4800	40	Blanco	1150X60X70H mm	Aluminio / PC	CCT	113,90



Accesorios



Driver Dali Lf-Gsd040Pf
 Driver Philips LM2284
 Kit conversión Driver 0-10v
 LF-GSP012YG Lf Aaa040B1050-42

conf. scatol.

1 pz	5 pz	IP20	50000 H	AC 170 265V	120°	CRI 90	F.P 0.95
------	------	------	---------	-------------	------	--------	----------



Iluminación Interior / Emergencias LED

M Emergencia LED Zovy Autotest



GARANTÍA
3 AÑOS

Ref	Lm	Vatios	Acaba- do	Dimensión	Material	Temperatura de color	PREZZO IVA escl.
LM1081	280	3	Blanco	260X90X50H mm	Termoplastico / PC	6000 K	32,90



conf. scatol.

1 pz	1 pz	IP20	30000 H	AC 170 265V	F.P 0.60
------	------	------	---------	----------------	-------------



AUTOTEST

La inspección mensual muestra que la luz verde parpadea durante **30 segundos al mes.**

La inspección anual muestra que la luz verde parpadea durante **2 minutos durante 1 año.**

Las inspecciones anuales y mensuales hacen que la luz verde parpadee durante la emergencia, y el estado de carga se devolverá automáticamente después de que se complete la inspección.

Las inspecciones mensuales y anuales se calculan **48 horas** después de que se usa el producto.

Presione rápidamente el botón de prueba dos veces para entrar al estado de inspección mensual, la luz verde parpadea lentamente, mientras parpadea durante la emergencia, volverá al estado de carga en aproximadamente **20-30 segundos.**

Presione rápidamente el botón **3 veces** para entrar al estado de inspección anual, la luz verde parpadea rápidamente, parpadea durante la emergencia y regresa al estado de carga en aproximadamente **2 minutos.**

M Módulo LED ArumLED 7W



GARANTÍA
5 AÑOS



Ref	Lm	Vatios	Acabado	Dimensión	Material	Temperatura de color	PREZZO IVAescl.
LM4301	700	7	Negro	45X50H mm	Aluminio / PC	6000 K	20,50
LM4302	700	7	Negro	45X50H mm	Aluminio / PC	4500 K	20,50
LM4303*	700	7	Negro	45X50H mm	Aluminio / PC	3000 K	20,50

Accesorios



Driver Triac
Lf-Gde014Yg
Kit conversión
LM2128

conf. scatol.

1 pz	50 pz	IP20	25000 H	AC 170 265V	36°	CRI 85	F.P 0.60
------	-------	------	---------	----------------	-----	-----------	-------------

M Aro para modulo ArumLED / GU10 / MR16 - Manu

GARANTÍA
3 AÑOS



Ref	Acabado	Dimensión	Dimensión Corte	Material	PREZZO IVAescl.
LM4333	Blanco	78 mm	91 mm	Aluminio	19,90

conf. scatol.

1 pz	20 pz
------	-------

*ordinabile





Aros y Accesorios

Aro para modulo ArumLED / GU10 / MR16 - Loau

GARANTÍA
3 AÑOS



Ref	Acabado	Dimensión	Dimensión Corte	Material	PREZZO IVAescl.
LM4334	Blanco	82 mm	78 mm	Aluminio	11,50

conf. scatola.

1 pz	15 pz
------	-------



Aros y Accesorios

Aro para modulo ArumLED / GU10 / MR16 - Maka

GARANTÍA
3 AÑOS



Ref	Acabado	Dimensión	Dimensión Corte	Material	PREZZO IVAescl.
LM4330	Blanco	86X40H mm	70 mm	Aluminio	5,85

conf. scatola.

1 pz	15 pz
------	-------





Aros y Accesorios

Aro para modulo ArumLED / GU10 / MR16 - Maika

GARANTÍA
3 AÑOS



Ref	Acabado	Dimensión	Dimensión Corte	Material	PREZZO IVA escl.
LM4332	Blanco	80X35H mm	72 mm	Aluminio	5,90

conf.	scatol.
1 pz	15 pz



Aros y Accesorios

Aro para modulo ArumLED / GU10 / MR16 - Lani

GARANTÍA
3 AÑOS



Ref	Acabado	Dimensión	Dimensión Corte	Material	PREZZO IVA escl.
LM4331	Blanco	80X30H mm	72 mm	Aluminio	10,45

conf.	scatol.
1 pz	15 pz





Aros y Accesorios

Aro para modulo ArumLED / GU10 / MR16 - Makaili

GARANTÍA
3 AÑOS



Ref	Acabado	Dimensión	Dimensión Corte	Material	PREZZO IVA escl.
LM4335	Blanco	88 mm	74 mm	Aluminio	7,40

conf.	scatol.
1 pz	15 pz



Aros y Accesorios

Aro para modulo ArumLED / GU10 / MR16 - Hopaka

GARANTÍA
3 AÑOS



Ref	Acabado	Dimensión	Dimensión Corte	Material	PREZZO IVA escl.
LM4336	Blanco	95X30H mm	80 mm	Aluminio	8,90

conf.	scatol.
1 pz	15 pz





Aros y Accesorios

Aro para modulo ArumLED / GU10 / MR16 - Miata

GARANTIA
3 AÑOS



Ref	Acabado	Dimensión	Dimensión Corte	Material	PREZZO IVA escl.
LM4337	Blanco	80X35H mm	72 mm	Aluminio	5,70

conf. scatol.

1 pz

15 pz



Iluminación Interior / Baliza LED

M Baliza LED Nomis Square Empotrable



GARANTÍA
3 AÑOS



Ref	Lm	Vatios	Acabado	Dimensión	Material	Temperatura de color	PREZZO IVA escl.
LM9003	120	1,2	Blanco	85X85H mm	PC Ignifugo	4500 K	9,70

conf. scatol.

1 pz	1pz	IP20	30000 H	AC 170 265V	CRI 80	Potencia max 600	Corte 60X60 mm
------	-----	------	---------	-------------	--------	------------------	----------------

Iluminación Interior / Baliza LED

M Baliza LED Nomis Square Empotrable con Sensor PIR



GARANTÍA
3 AÑOS



Ref	Lm	Vatios	Acabado	Dimensión	Material	Temperatura de color	PREZZO IVA escl.
LM9001	120	1,2	Blanco	85X85H mm	PC Ignifugo	4500 K	12,90

conf. scatol.

1 pz	1pz	IP20	30000 H	AC 170 265V	CRI 80	Potencia max 600	Corte 60X60 mm
------	-----	------	---------	-------------	--------	------------------	----------------

Incluye sensor de movimiento PIR, con un mínimo de 10 lux se activara el sensor de movimiento, de esa manera permitirá el funcionamiento únicamente con la falta de claridad.

Válido para cajas de mecanismos universales.

Los sensores PIR, también llamados pirólicos, son un tipo de sensor óptico muy empleado para detectar el movimiento de personas, en especial en alumbrados automatizados. Veamos a continuación, cómo funcionan este tipo de sensores y cómo están constituidos.

Constitución Interna

Consisten en 2 elementos fundamentales, un lente que hace que los rayos incidentes recaigan sobre un punto y el sensor PIR como tal.

El sensor PIR tiene dos elementos sensibles a la luz, que al medirse el retardo de detección entre cada sensor, es posible calcular la distancia a la que se encuentra el objeto.

¿Cómo detecta el sensor PIR?

Los sensores PIR son de tipo ópticos, es decir, se basan en cambios en la radiación electromagnética para sentir el entorno. En lo particular, los sensores PIR trabajan en el rango de la luz infrarroja.

Se les conoce como piroeléctricos debido a que los objetos que emiten mayor radiación infrarroja son aquellos cuya temperatura es mayor.

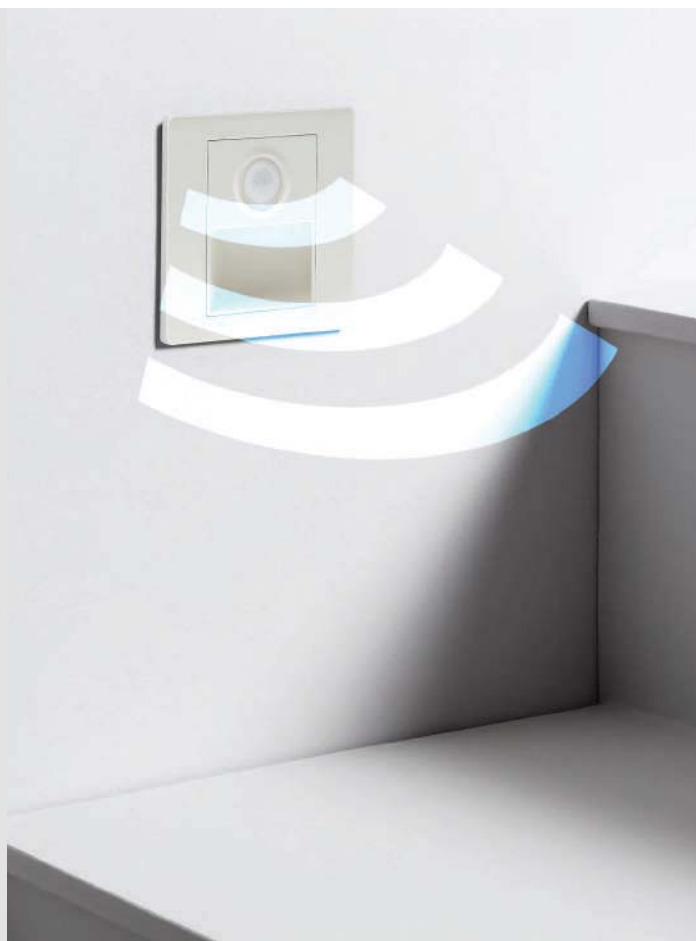

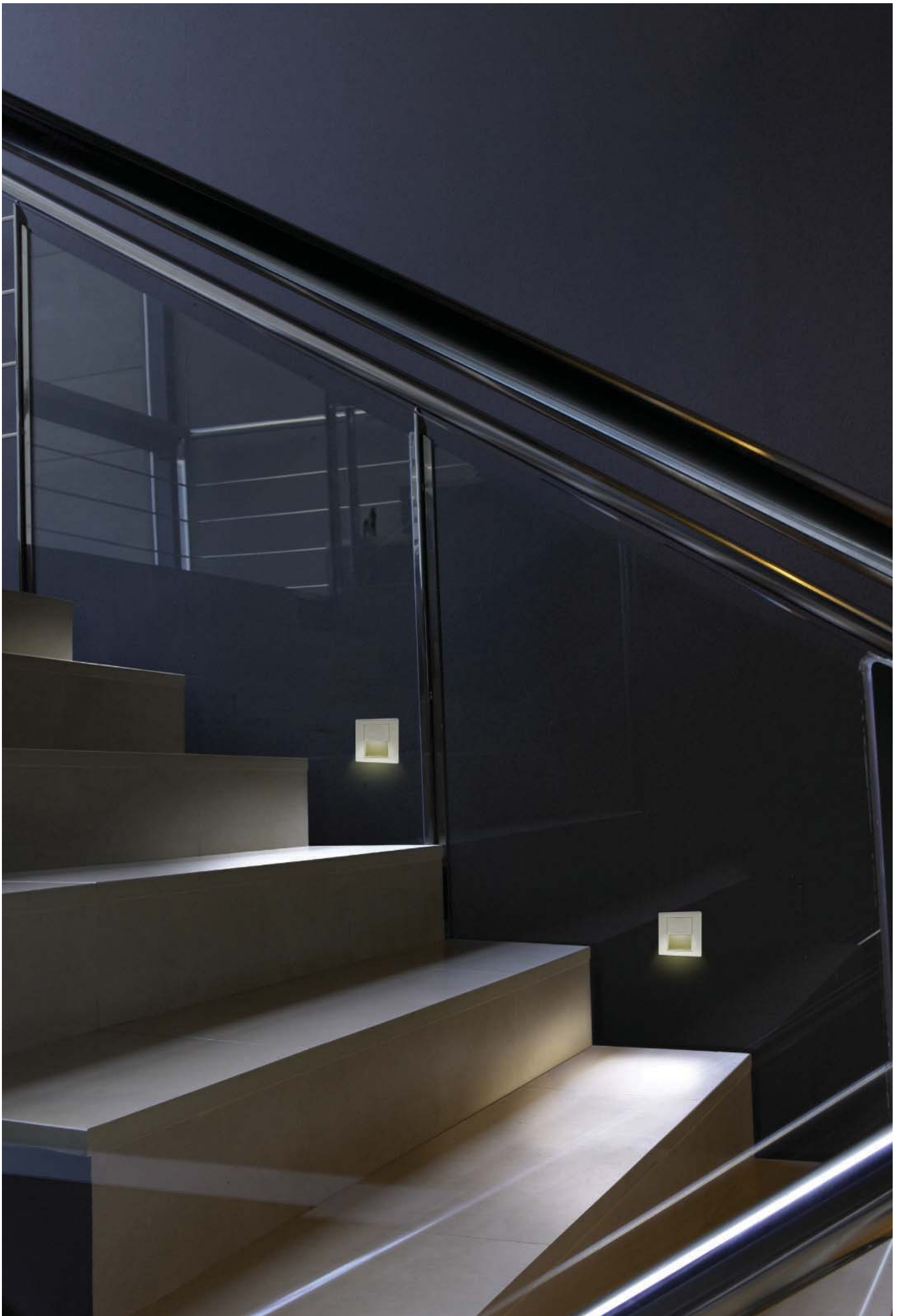



ILUMINACION EXTERIOR

Iluminación Exterior / Apliques de pared

M Aplique LED Sphere Sensor Movimiento



GARANTÍA
3 AÑOS



Ref	Lm	Vatios	Acabado	Dimensión	Material	Temperatura de color	PREZZO IVA escl.
LM8225	960	12	Blanco	170X75H mm	PC	6000K	32,60
LM8226	960	12	Blanco	170X75H mm	PC	4500K	32,60

conf. scatol.

1 pz	30 pz	IP64	30000 H	AC 220 240V	120°	- 20°C + 40°C	CRI 80	Regulación tiempo 10 lux	Tiempo min/max 10-75seg	Angulo deteccion 360°	Deteccion 6 m
------	-------	------	---------	-------------	------	---------------	--------	--------------------------	-------------------------	-----------------------	---------------

Iluminación Exterior / Plafones LED de Exterior

M Plafón LED Oval Screw



GARANTÍA
3 AÑOS



Ref	Lm	Vatios	Acabado	Dimensión	Material	Temperatura de color	PREZZO IVA escl.
LM8241	2000	20	Blanco	268X78X143H mm	PC	6000K	14,50
LM8242	2000	20	Blanco	268X78X143H mm	PC	4500K	14,50

conf. scatol.

1 pz	32 pz	IP65	25000 H	AC 110 240V	120°	CRI 70
------	-------	------	---------	-------------	------	--------

Iluminación Exterior / Plafones LED de Exterior

M Plafón LED Screw 20W IP65



GARANTÍA
3 AÑOS



Ref	Lm	Vatios	Acabado	Dimensión	Material	Temperatura de color	PREZZO IVA escl.
LM8243	2000	20	Blanco	219X68 mm	PC	6000K	16,90
LM8244	2000	20	Blanco	219X68 mm	PC	4500K	16,90

conf. scatol.

1 pz	30 pz	IP65	25000 H	AC 110 240V	120°	CRI 70
------	-------	------	---------	-------------	------	--------

Iluminación Exterior / Plafones LED de Exterior

M Plafón LED Sphere Con Sensor Movimiento



GARANTÍA
3 AÑOS



Ref	Lm	Vatios	Acabado	Dimensión	Material	Temperatura de color	PREZZO IVA escl.
LM8215	960	12	Blanco	230X105X40H mm	PC	6000K	36,90
LM8216	960	12	Blanco	230X105X40H mm	PC	4000K	36,90

conf. scatol.

1 pz	32 pz	IP54	30000 H	AC 220 240V	120°	- 20°C + 40°C	Detección 6 m max	Tiempo min - max 10 - 75 seg	Detección < 10 Lux
------	-------	------	---------	-------------	------	---------------	-------------------	------------------------------	--------------------

Iluminación Exterior / Apliques de pared

M Aplique Led Cinza



GARANTÍA
3 AÑOS

Ref	Lm	Vatios	Acabado	Dimensión	Material	Temperatura de color	PREZZO IVA escl.
LM6118	840	12	Negro	170X170X100H mm	Aluminio / PC	CCT	39,40

conf. scatol.

1 pz	20 pz	IP65	30000 H	AC 175 265V	180°	CRI 80
------	-------	------	---------	-------------	------	--------

Iluminación Exterior / Apliques de pared

M Aplique Led Dynamic



GARANTÍA
3 AÑOS

Ref	Lm	Vatios	Acabado	Dimensión	Material	Temperatura de color	PREZZO IVA escl.
LM6117	840	12	Negro	170X170X95H mm	Aluminio / PC	CCT	39,40

conf. scatol.

1 pz	20 pz	IP65	30000 H	AC 175 265V	180°	CRI 80
------	-------	------	---------	-------------	------	--------

Iluminación Exterior / Apliques de pared

M Aplique de pared LED Tube



GARANTÍA
3 AÑOS

Ref	Lm	Vatios	Acabado	Dimensión	Material	Temperatura de color	PREZZO IVA escl.
LM6179	540	6	Negro	130X112H mm	Aluminio / Cristal	3000K	38,40
LM6188	540	6	Blanco	130X112H mm	Aluminio / Cristal	3000K	38,40

conf. scatol.

1 pz	20 pz	IP65	30000 H	AC 175 265V	36°	CRI 80
------	-------	------	---------	-------------	-----	--------

Iluminación Exterior / Apliques de pared

M Aplique de Pared LED Cube



GARANTÍA
3 AÑOS

Ref	Lm	Vatios	Acabado	Dimensión	Material	Temperatura de color	PREZZO IVA escl.
LM6182	540	6	Negro	100X100X100H mm	Aluminio	3000K	35,90
LM6197	540	6	Blanco	100X100X100H mm	Aluminio	3000K	35,90
LM6184	1200	12	Negro	100X100X100H mm	Aluminio	CCT	38,50
LM6183	1200	12	Blanco	100X100X100H mm	Aluminio	CCT	38,50

conf. scatol.

1 pz	1 pz	IP54	50000 H	AC 175 265V	10°-90°	CRI 80
------	------	------	---------	-------------	---------	--------



Iluminación Exterior / Baliza LED

M Baliza Cam



GARANTÍA
3 AÑOS

Ref	Acabado	Dimensión	Material	PREZZO IVA escl.
LM7314	Negro	180X500H mm	Aluminio / PMMA	55,00
LM7315	Negro	180X800H mm	Aluminio / PMMA	67,90

conf. scatol.

1 pz	5 pz	IP44	Pot max 40
------	------	------	------------

Iluminación Exterior / Baliza LED

M Baliza Double Urban



GARANTÍA
3 AÑOS

Ref	Acabado	Dimensión	Material	PREZZO IVA escl.
LM7317	Negro	216X440H mm	Aluminio / PMMA	71,00

conf. scatol.

1 pz	6 pz	IP44	Pot max 40
------	------	------	------------

Iluminación Exterior / Baliza LED

M Baliza Urban



GARANTÍA
3 AÑOS

Ref	Acabado	Dimensión	Material	PREZZO IVA escl.
LM7316	Negro	104X440H mm	Aluminio / PMMA	55,00

conf. scatol.

1 pz	10 pz	IP44	Pot max 40
------	-------	------	------------

Iluminación Exterior / Baliza LED

M Baliza Design Plus



GARANTÍA
3 AÑOS

Ref	Acabado	Dimensión	Material	PREZZO IVA escl.
LM7312	Negro	80X80X440H mm	Aluminio / PMMA	48,90
LM7313	Negro	80X80X740H mm	Aluminio / PMMA	60,90

conf. scatol.

1 pz	6 pz	IP44	Pot max 40
------	------	------	------------



Iluminación Exterior / Apliques de pared

M Aplique Urban



GARANTÍA
3 AÑOS

Ref	Acabado	Dimensión	Material	PREZZO IVA escl.
LM6169	Negro	130X172,5H mm	Aluminio / PMMA	38,00

conf.	scatol.		
1 pz	10 pz	IP44	Pot max 40

Iluminación Exterior / Apliques de pared

M Aplique Cam



GARANTÍA
3 AÑOS

Ref	Acabado	Dimensión	Material	PREZZO IVA escl.
LM6168	Negro	214X180X278H mm	Aluminio / PMMA	37,90

conf.	scatol.		
1 pz	10 pz	IP44	Pot max 40

Iluminación Exterior / Apliques de pared

M Aplique de pared Tube



GARANTÍA
3 AÑOS

Ref	Acabado	Dimensión	Material	PREZZO IVA escl.
LM6189	Negro	112X191H mm	Aluminio / Cristal	38,90
LM6196	Blanco	112X191H mm	Aluminio / Cristal	26,90

conf.	scatol.		
1 pz	20 pz	IP54	

Iluminación Exterior / Apliques de pared

M Aplique Design



GARANTÍA
3 AÑOS

Ref	Acabado	Dimensión	Material	PREZZO IVA escl.
LM7311	Negro	80X112X160H mm	Aluminio / PMMA	29,90

conf.	scatol.		
1 pz	15 pz	IP44	Pot max 40



M Iluminación Exterior / Baliza LED
**Baliza LED Enfine
 Empotrable**



GARANTÍA
3 AÑOS



Ref	Lm	Vatios	Acabado	Corte	Dimensión	Material	Temperatura de color	PREZZO IVA escl.
LM6195	160	2	Negro	113X59X58 mm	147X71X62 mm	Aluminio	3000K	24,40

conf. scatol.

1 pz	10 pz	IP54	50000 H	AC 175 265V	36°	CRI 80
------	-------	------	---------	-------------	-----	--------

M Iluminación Exterior / Baliza LED
**Baliza LED
 Line Empotrable**



GARANTÍA
3 AÑOS



Ref	Lm	Vatios	Acabado	Corte	Dimensión	Material	Temperatura de color	PREZZO IVA escl.
LM6192	240	3	Negro	66X66X46 mm	85X85X50 mm	Aluminio	3000K	20,90

conf. scatol.

1 pz	10 pz	IP54	40000 H	AC 175 265V	36°	CRI 80
------	-------	------	---------	-------------	-----	--------

M Iluminación Exterior / Baliza LED
**Baliza LED
 Desan Empotrable**



GARANTÍA
3 AÑOS



Ref	Lm	Vatios	Acabado	Corte	Dimensión	Material	Temperatura de color	PREZZO IVA escl.
LM6191	240	3	Negro	66X66X46 mm	85X85X50 mm	Aluminio	3000K	18,90

conf. scatol.

1 pz	10 pz	IP54	40000 H	AC 175 265V	36°	CRI 80
------	-------	------	---------	-------------	-----	--------

M Iluminación Exterior / Baliza LED
**Baliza LED Circle
 Empotrable**



GARANTÍA
3 AÑOS



Ref	Lm	Vatios	Acabado	Corte	Dimensión	Material	Temperatura de color	PREZZO IVA escl.
LM6193	240	3	Negro	65 mm	82X40 mm	Aluminio	3000K	19,50

conf. scatol.

1 pz	10 pz	IP54	40000 H	AC 175 265V	36°	CRI 80
------	-------	------	---------	-------------	-----	--------

Iluminación Exterior / Baliza LED

M Baliza LED Biral de Superficie



GARANTÍA 3 AÑOS



Ref	Lm	Vatios	Acabado	Dimensión	Material	Temperatura de color	PREZZO IVA escl.
LM6194	240	3	Negro	80X75X50 mm	Aluminio	3000K	23,90

conf. scatol.

1 pz	10 pz	IP54	40000 H	AC 175 265V	36°	CRI 80
------	-------	------	---------	-------------	-----	--------

Iluminación Exterior / Focos Empotrables

M Foco empotrable GubBet Para suelo GU10



GARANTÍA 3 AÑOS



Ref	Acabado	Corte	Dimensión	Material	PREZZO IVA escl.
LM7303	Acero Inoxidable	100 mm	110X130H mm	Acero / PC	23,20
LM7302	Acero Inoxidable	100 mm	110X110X130H mm	Acero / PC	24,90

conf. scatol.

1 pz	30 pz	IP67	Pot max 40
------	-------	------	------------

Iluminación Exterior / Focos LED con pincho

M Foco proyector Ventur Con Pincho para GU10



GARANTÍA 3 AÑOS



Ref	Acabado	Dimensión	Material	PREZZO IVA escl.
LM7301	Negro	100X310H mm	Aluminio	22,40

conf. scatol.

1 pz	30 pz	IP54	Pot max 40
------	-------	------	------------

Iluminación Exterior / Iluminación LED Solar

M Aplique Led Jano Solar



GARANTÍA 3 AÑOS



Ref	Lm	Vatios	Acabado	Dimensión	Material	Temperatura de color	PREZZO IVA escl.
LM6439	150	1	Blanco	105X155X113H mm	Aluminio	4500K	42,40

conf. scatol.

1 pz	20 pz	IP65	30000 H	IK8	36°	CRI 80	3.7V 800 mAh	Carga 5-6Hr	Uso 6-8Hr	Sensor crepuscular Movimiento
------	-------	------	---------	-----	-----	--------	--------------	-------------	-----------	-------------------------------

Iluminación Exterior / Iluminación LED Solar

M Aplique Led Solar Cory



GARANTÍA
3 AÑOS



Ref	Lm	Vatios	Acabado	Dimensión	Material	Temperatura de color	PREZZO IVA escl.
LM6438	150	1	Blanco	105X155X113H mm	Aluminio	4500K	42,90

conf. scatol.

1 pz	20 pz	IP65	30000 H	IK8	36°	CRI 80	3.7V 800 mAh	Carga 5-6Hr	Uso 6-8Hr	Sensor crepuscular Movimiento
------	-------	------	---------	-----	-----	--------	--------------	-------------	-----------	-------------------------------

Iluminación Exterior / Iluminación LED Solar

M Baliza Led Solar Buy De suelo con pincho

GARANTÍA
3 AÑOS



Ref	Lm	Vatios	Acabado	Dimensión	Material	Temperatura de color	PREZZO IVA escl.
LM7304	90	3	Negro	121X121X24 mm	PC	3000K	13,90

conf. scatol.

1 pz	72 pz	IP66	30000 H	IK9	360°	CRI 90	3.7V 800 mAh	Carga 5-6Hr	Uso 6-8Hr	Sensor crepuscular
------	-------	------	---------	-----	------	--------	--------------	-------------	-----------	--------------------

Iluminación Exterior / Iluminación LED Solar

M Aplique LED Solar Mustang con Sensor Movimiento

GARANTÍA
3 AÑOS



Ref	Lm	Vatios	Acabado	Dimensión	Material	Temperatura de color	PREZZO IVA escl.
LM6437	450	10	Negro	130X95X50 mm	PC	4500K	18,90

conf. scatol.

1 pz	50 pz	IP44	30000 H	120°	Carga 3-4Hr	Uso 4-6Hr	Sensor crepuscular Movimiento
------	-------	------	---------	------	-------------	-----------	-------------------------------

Iluminación Exterior / Iluminación LED Solar

M Aplique LED Solar Venus con Sensor Movimiento

GARANTÍA
3 AÑOS



Ref	Lm	Vatios	Acabado	Dimensión	Material	Temperatura de color	PREZZO IVA escl.
LM6436	300	6	Negro	200X105X45 mm	PC	4500K	29,90

conf. scatol.

1 pz	50 pz	IP44	30000 H	120°	Carga 3-4Hr	Uso 4-6Hr	Sensor crepuscular Movimiento
------	-------	------	---------	------	-------------	-----------	-------------------------------

Iluminación Exterior / Iluminación LED Solar

M Aplique LED Solar Natur con Sensor Movimiento

GARANTÍA
3 AÑOS



Ref	Lm	Vatios	Acabado	Dimensión	Material	Temperatura de color	PREZZO IVAescl.
LM6435	500	12	Negro	300X105X48 mm	PC	4500K	39,90

conf.	scatol.	IP44	30000 H	120°	Carga 3-4Hr	Uso 4-6Hr	Sensor crepuscular Movimiento
1 pz	40 pz						

Iluminación Exterior / Iluminación LED Solar

M Aplique LED Solar Mus con Sensor Movimiento

GARANTÍA
3 AÑOS



Ref	Lm	Vatios	Acabado	Dimensión	Material	Temperatura de color	PREZZO IVAescl.
LM6434	150	3	Negro	120X55X100 mm	PC	4500K	16,90

conf.	scatol.	IP44	30000 H	120°	Carga 3-4Hr	Uso 4-6Hr	Sensor crepuscular Movimiento
1 pz	40 pz						

Iluminación Exterior / Iluminación LED Solar

M Aplique LED Solar Moon con Sensor Movimiento

GARANTÍA
3 AÑOS



Ref	Lm	Vatios	Acabado	Dimensión	Material	Temperatura de color	PREZZO IVAescl.
LM6433	150	3	Negro	100X110X40 mm	PC	4500K	14,80

conf.	scatol.	IP44	30000 H	120°	Carga 3-4Hr	Uso 4-6Hr	Sensor crepuscular Movimiento
1 pz	40 pz						

Iluminación Exterior / Iluminación LED Solar

M Aplique LED Solar Sun con Sensor Movimiento

GARANTÍA
3 AÑOS



Ref	Lm	Vatios	Acabado	Dimensión	Material	Temperatura de color
LM6432	200	4	Negro	170X120X40 mm	PC	4500K

IP44	30000 H	120°	Carga 3-4Hr	Uso 4-6Hr	Sensor crepuscular Movimiento

Iluminación Exterior / Iluminación LED Solar

M Aplique LED Solar Star

GARANTÍA
3 AÑOS



Ref	Lm	Vatios	Acabado	Dimensión	Material	Temperatura de color	PREZZO IVA escl.
LM6431	150	3	Aluminio	112X48 mm	PC	4500K	9,50

conf. scatol.

1 pz	40 pz	IP44	30000 H	120°	Carga 3-4Hr	Uso 4-6Hr	Sensor crepuscular
------	-------	------	---------	------	----------------	--------------	-----------------------

Iluminación Exterior / Iluminación LED Solar

M Foco Proyector Led Solar Venecia

INCLUYE
CONTROL
REMOTO



GARANTÍA
3 AÑOS



Ref	Lm	Vatios	Acabado	Dimensión	Material	Temperatura de color	PREZZO IVA escl.
LM6521	2250	50	Gris	200X35X220H mm	Aluminio / PC	6000K	73,00
LM6522	2250	50	Gris	200X35X220H mm	Aluminio / PC	4500K	73,00
LM6524	4500	100	Gris	241X35X279H mm	Aluminio / PC	6000K	135,00
LM6525	4500	100	Gris	241X35X279H mm	Aluminio / PC	4500K	135,00
LM6527	9000	200	Gris	270X35X314H mm	Aluminio / PC	6000K	158,00
LM6528	9000	200	Gris	270X35X314H mm	Aluminio / PC	4500K	158,00

1 pz	10 pz	IP66	50000 H	IK8	120°	- 20°C + 45°C	CRI 80	Carga 10-12Hr	Uso 10-12Hr	Sensor crepuscular Movimiento
------	-------	------	---------	-----	------	------------------	-----------	------------------	----------------	-------------------------------------

conf. scatol.

MODO DÍA / NOCHE
Utilizable durante el día y durante la noche



Tamaño Placa 50W/100W/200W
Plate Size 50W/100W/200W

200X35X220H mm
241X35X279H mm
270X35X314H mm

Tiempo de carga / Time charge
10-12 Hr

Sensor
Sensor
Movimiento

Autonomía / Autonomy
10-12 Horas

Protección / Protection
IP66



Iluminación Exterior / Iluminación LED Solar / Aros y Accesorios

M Solar LED SphereGlass Vintage exterior

GARANTÍA
3 AÑOS



Ref	Dimensión	Material	Temperatura de color	PREZZO IVA escl.
LM8073	125X125X145H mm	Cristal	RGB	17,80
LM8074	125X125X145H mm	Cristal	3000K	13,90

conf. scatol.

1 pz	24 pz	IP40	Carga 2-3Hr	Uso 2-3Hr	Sensor crepuscular Movimiento
------	-------	------	-------------	-----------	-------------------------------

Iluminación Exterior / Iluminación LED Solar / Projectores LED con Batería

M Proyector Solar LED Portátil Con Batería Power Bank



GARANTÍA
3 AÑOS



Ref	Lm	Vatios	Acabado	Dimensión	Material	Temperatura de color	PREZZO IVA escl.
LM6335	4500	50	Negro / Amarillo	205X146X60H mm	ABS	6000K	46,70
LM6336	2700	30	Negro / Amarillo	175X146X60H mm	ABS	6000K	37,50

conf. scatol.

1 pz	30 pz	IP66	50000 H	DC 5V	120°	Carga 8 Hr	Uso 8-36Hr
------	-------	------	---------	-------	------	------------	------------



Iluminación Exterior / Iluminación LED Solar / Focos Led para Piscina

M Foco LED Must Para Piscina Solar

INCLUYE
CONTROL
REMOTO



GARANTÍA
3 AÑOS



Ref	Lm	Vatios	Acabado	Dimensión	Material	Temperatura de color	PREZZO IVAescl.
LM6411	200	5	Negro	295X21H mm	PC	6000K	105,00

conf. scatol.

1 pz	20 pz	IP68	30000 H	180°	IK8	CRI 75	Carga 8-10Hr	Uso 6-8Hr	3.7V 4400 mAh	Sensor crepuscular
------	-------	------	---------	------	-----	--------	--------------	-----------	---------------	--------------------



Iluminación Exterior / Proyectores LED con Batería

M Foco proyector LED Portátil con Batería Laptop



INCLUYE CARGADOR

LED provided by EPISTAR

GARANTÍA 3 AÑOS

Ref	Lm	Vatios	Acabado	Dimensión	Material	Temperatura de color	PREZZO IVA escl.
LM6031	1800	20	Negro / Amarillo	260X283H mm	Aluminio / PMMA	6000K	58,90
LM6032	2700	30	Negro / Amarillo	296X315H mm	Aluminio / PMMA	6000K	83,90
LM6033	4500	50	Negro / Amarillo	352X345H mm	Aluminio / PMMA	6000K	111,00

conf. scatol.

1 pz	6 pz	Uso 4-8Hr	IP65	30000 H	AC 180 220V	120°	CRI 80
------	------	-----------	------	---------	-------------	------	--------

Iluminación Exterior / Proyectores LED RGB

M Foco Proyector Led Napoli



INCLUYE CONTROL REMOTO

LED provided by OSRAM

GARANTÍA 3 AÑOS

Ref	Vatios	Onda	Acabado	Dimensión	Material	Temperatura de color	PREZZO IVA escl.
LM6511	20	R-620-630 G-510-525 B-455-470 nm	Negro	104X22,8X120,4H mm	Aluminio / Cristal	RGB	23,40
LM6512	50	R-620-630 G-510-525 B-455-470 nm	Negro	164,2X31,7X194,9H mm	Aluminio / Cristal	RGB	39,00
LM6513	100	R-620-630 G-510-525 B-455-470 nm	Negro	198,6X33X223,8H mm	Aluminio / Cristal	RGB	66,60

conf. scatol.

1 pz	20 pz	Regulable	IP65	50000 H	AC 180 265V	IK8	120°	- 20°C + 45°C	CRI 80	F.P 0.98	KV 2
------	-------	-----------	------	---------	-------------	-----	------	---------------	--------	----------	------

Iluminación Exterior / Proyectores LED RGB

M Foco proyector LED SMD



INCLUYE CONTROL REMOTO

LED provided by SANAN

GARANTÍA 3 AÑOS

Ref	Vatios	Onda	Acabado	Dimensión	Material	Temperatura de color	PREZZO IVA escl.
LM6616	20	R-620-630 G-510-525 B-455-470 nm	Negro	270X53X235H mm	Aluminio / Cristal	RGB	42,00
LM6617	30	R-620-630 G-510-525 B-455-470 nm	Negro	215X45X195H mm	Aluminio / Cristal	RGB	51,00
LM6618	50	R-620-630 G-510-525 B-455-470 nm	Negro	270X53X235H mm	Aluminio / Cristal	RGB	63,00

conf. scatol.

1 pz	15 pz	Regulable	IP66	50000 H	AC 85 265V	IK8	120°	- 20°C + 45°C	CRI 80	F.P 0.98
------	-------	-----------	------	---------	------------	-----	------	---------------	--------	----------

Iluminación Exterior / Projectores LED SMD

M Foco Proyector Led Infinity



Ref	Lm	Vatios	Acabado	Dimensión	Material	Temperatura de color	PREZZO IVA escl.
LM6460	7200	60	Gris	218X46X285H mm	Aluminio / Cristal	6000K	185,00
LM6461	12000	100	Gris	235X48X315H mm	Aluminio / Cristal	6000K	229,00
LM6462	18000	150	Gris	255X49X386H mm	Aluminio / Cristal	6000K	272,00
LM6465	18000	150	Gris	255X49X386H mm	Aluminio / Cristal	4000K	272,00
LM6466	18000	150	Gris	255X49X386H mm	Aluminio / Cristal Accesorios	3000K	272,00



Convertor a Dali
LF-SCD010B
Brazo articulado
LM6652

conf. scatol.

1 pz	4 pz	IP65	40000 H	AC 110 240V	IK8	145° X 70°	- 40°C + 65°C	CRI 70	F.P 0.90	KV 6	Regulable 1-10V
------	------	------	---------	----------------	-----	------------------	------------------	-----------	-------------	---------	--------------------



1. Quitar los tapones para proceder a la colocación del brazo articulado.



2. Quitar la sujecion del foco.



3. Colocar el brazo articulado y atornillarlo coincidiendo en sus orificios.



4. El foco esta listo para la instalación en poste para usarlo como farola.

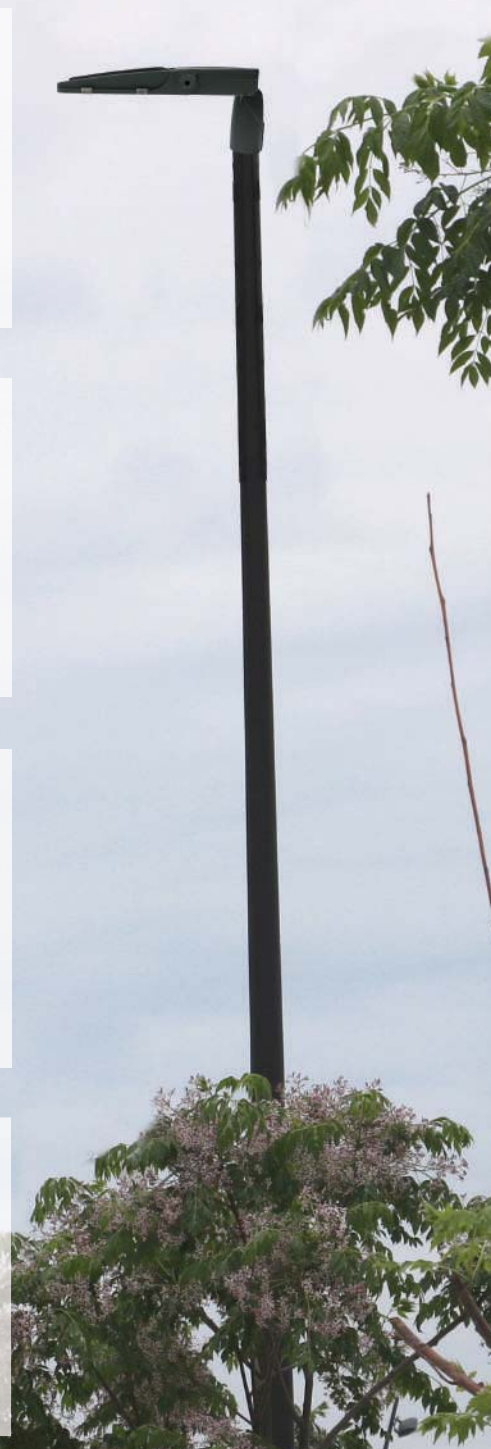

Iluminación Exterior / Projectores LED SMD

M Foco Proyector Led Slim Series



GARANTÍA
5 AÑOS



Ref	Lm	Vatios	Acabado	Dimensión	Material	Temperatura de color	PREZCO IVA escl.
LM6570	14000	100	Negro	343X56X369H mm	Aluminio / Cristal	5000K	142,00
LM6571	14000	100	Negro	343X56X369H mm	Aluminio / Cristal	4000K	143,00
LM6573	21000	150	Negro	343X56X369H mm	Aluminio / Cristal	5000K	159,00
LM6574	21000	150	Negro	343X56X369H mm	Aluminio / Cristal	4000K	1159,00
LM6576	28000	200	Negro	368X58X412H mm	Aluminio / Cristal	5000K	211,00
LM6577	28000	200	Negro	368X58X412H mm	Aluminio / Cristal	4000K	211,00
LM6579	42000	300	Negro	393X58X422H mm	Aluminio / Cristal	5000K	299,00
LM6580	42000	300	Negro	393X58X422H mm	Aluminio / Cristal	4000K	299,00

Accesorios



Convertor a Dali
LF-SCD010B

conf. scatol.

1 pz	4 pz	IP65	50000 H	AC 100 277V	IK8	90°	- 40°C + 55°C	CRI 70	F.P 0.90	Regulable 1-10V
------	------	------	---------	----------------	-----	-----	------------------	-----------	-------------	--------------------



Iluminación Exterior / Proyectores LED SMD

M Foco Proyector Led Napoli



GARANTÍA
3 AÑOS



Ref	Lm	Vatios	Acabado	Dimensión	Material	Temperatura de color	PREZZO IVA escl.
LM6381	2400	20	Negro	104X22,8X120,4H mm	Aluminio / Cristal	6000K	10,70
LM6382	2400	20	Negro	104X22,8X120,4H mm	Aluminio / Cristal	4500K	10,70
LM6383	2400	20	Negro	104X22,8X120,4H mm	Aluminio / Cristal	3000K	10,70
LM6384	6000	50	Negro	164,2X31,7X194,9H mm	Aluminio / Cristal	6000K	19,85
LM6385	6000	50	Negro	164,2X31,7X194,9H mm	Aluminio / Cristal	4500K	19,85
LM6386	6000	50	Negro	164,2X31,7X194,9H mm	Aluminio / Cristal	3000K	19,85
LM6387	12000	100	Negro	198,6X33X233,8H mm	Aluminio / Cristal	6000K	35,70
LM6388	12000	100	Negro	198,6X33X233,8H mm	Aluminio / Cristal	4500K	35,70
LM6389	12000	100	Negro	198,6X33X233,8H mm	Aluminio / Cristal	3000K	34,70
LM6390	18000	150	Negro	229,6X33X267,2H mm	Aluminio / Cristal	6000K	63,30
LM6391	18000	150	Negro	229,6X33X267,2H mm	Aluminio / Cristal	4500K	63,30
LM6392	18000	150	Negro	229,6X33X267,2H mm	Aluminio / Cristal	3000K	63,30
LM6393	24000	200	Negro	265,1X33X308,3H mm	Aluminio / Cristal	6000K	89,30
LM6394	24000	200	Negro	265,1X33X308,3H mm	Aluminio / Cristal	4500K	89,30
LM6395	24000	200	Negro	265,1X33X308,3H mm	Aluminio / Cristal	3000K	89,30

conf. scatol.

1 pz	20 pz	IP65	50000 H	AC 180 265V	IK6	120°	- 20°C + 45°C	CRI 80	F.P 0.90	Regulable Triac
------	-------	------	---------	----------------	-----	------	------------------	-----------	-------------	--------------------

Iluminación Exterior / Proyectores LED SMD

M Foco Proyector LED SMD Pro



GARANTÍA
3 AÑOS



Ref	Lm	Vatios	Acabado	Dimensión	Material	Temperatura de color	PREZZO IVA escl.
LM6658	3300	30	Negro	235X57X190H mm	Aluminio / Cristal	6000K	
LM6659	5500	50	Negro	240X64X281H mm	Aluminio / Cristal	6000K	41,90
LM6663	5500	50	Negro	240X64X281H mm	Aluminio / Cristal	4500K	41,90
LM6664	5500	50	Negro	240X64X281H mm	Aluminio / Cristal	3000K	41,90
LM6660	11000	100	Negro	284X85X334H mm	Aluminio / Cristal	6000K	74,90
LM6665	11000	100	Negro	284X85X334H mm	Aluminio / Cristal	4500K	74,90
LM6666	11000	100	Negro	284X85X334H mm	Aluminio / Cristal	3000K	74,90
LM6661	16500	150	Negro	310X85X345H mm	Aluminio / Cristal	6000K	113,90
LM6667	16500	150	Negro	310X85X345H mm	Aluminio / Cristal	4500K	113,90
LM6668	16500	150	Negro	310X85X345H mm	Aluminio / Cristal	3000K	113,90
LM6662	22000	200	Negro	310X215X345H mm	Aluminio / Cristal	6000K	136,90
LM6670	22000	200	Negro	310X215X345H mm	Aluminio / Cristal	4500K	136,90
LM6671	22000	200	Negro	310X215X345H mm	Aluminio / Cristal	3000K	136,90

conf. scatol.

1 pz	10 pz	IP65	50000 H	AC 175 265V	120°	- 20°C + 45°C	CRI 80	F.P 0.98	KV 6
------	-------	------	---------	----------------	------	------------------	-----------	-------------	---------

Iluminación Exterior / Projectores LED SMD con Sensor

M Foco Proyector Led Napoli Con Sensor de movimiento



GARANTÍA
3 AÑOS



Ref	Lm	Vatios	Acabado	Dimensión	Material	Temperatura de color	PREZZO IVAescl.
LM6515	2400	20	Negro	104X22,8X120,4H mm	Aluminio / Cristal	6000K	24,90
LM6516	3600	30	Negro	164,2X31,7X194,90H mm	Aluminio / Cristal	6000K	34,90
LM6517	12000	100	Negro	198,6X33X233,8H mm	Aluminio / Cristal	6000K	49,90

conf.

1 pz	IP65	30000 H	AC 170 265V	IK6	120°	CRI 80	F.P 0.90	Tiempo max 20seg 30 min	Angulo deteccion 180°	Deteccion 8 m
------	------	---------	----------------	-----	------	-----------	-------------	----------------------------------	-----------------------------	------------------



Luz en Movimiento



Activación del sensor a partir de **20 Lux**
 Angulo de detección **180°**
 Distancia de detección **8 metros.**

- ON/OFF:** Encender y apagar.
- 8H:** Enciende **8 horas.**
- 20s:** Luz temporizada durante **20 segundos.**
- 1M:** Luz temporizada durante **1 minuto.**
- 2M:** Luz temporizada durante **2 minutos.**
- 5M:** Luz temporizada durante **5 minutos.**
- 10M:** Luz temporizada durante **10 minutos.**
- 30M:** Luz temporizada durante **30 minutos.**



Iluminación Exterior / Projectores LED SMD

M Foco Proyector Led Planet



GARANTÍA
5 AÑOS



Ref	Lm	Vatios	Acabado	Dimensión	Material	Temperatura de color	PREZZO IVA escl.
LM6470	50000	400	Negro	445X320X483H mm	Aluminio / PMMA	6000K	865,00
LM6471	50000	400	Negro	445X320X483H mm	Aluminio / PMMA	4500K	865,00
LM6472	72000	600	Negro	537X373X581H mm	Aluminio / PMMA	6000K	1.155,00
LM6473	72000	600	Negro	537X373X581H mm	Aluminio / PMMA	4500K	1.155,00

Accesorios



Convertor a Dali
LF-SCD010B

conf.

1 pz

IP65

50000 H

IK8

60°

AC 90
265V

IK8

60°

- 40°C
+ 65°C

CRI
70

F.P
0.90

KV
6



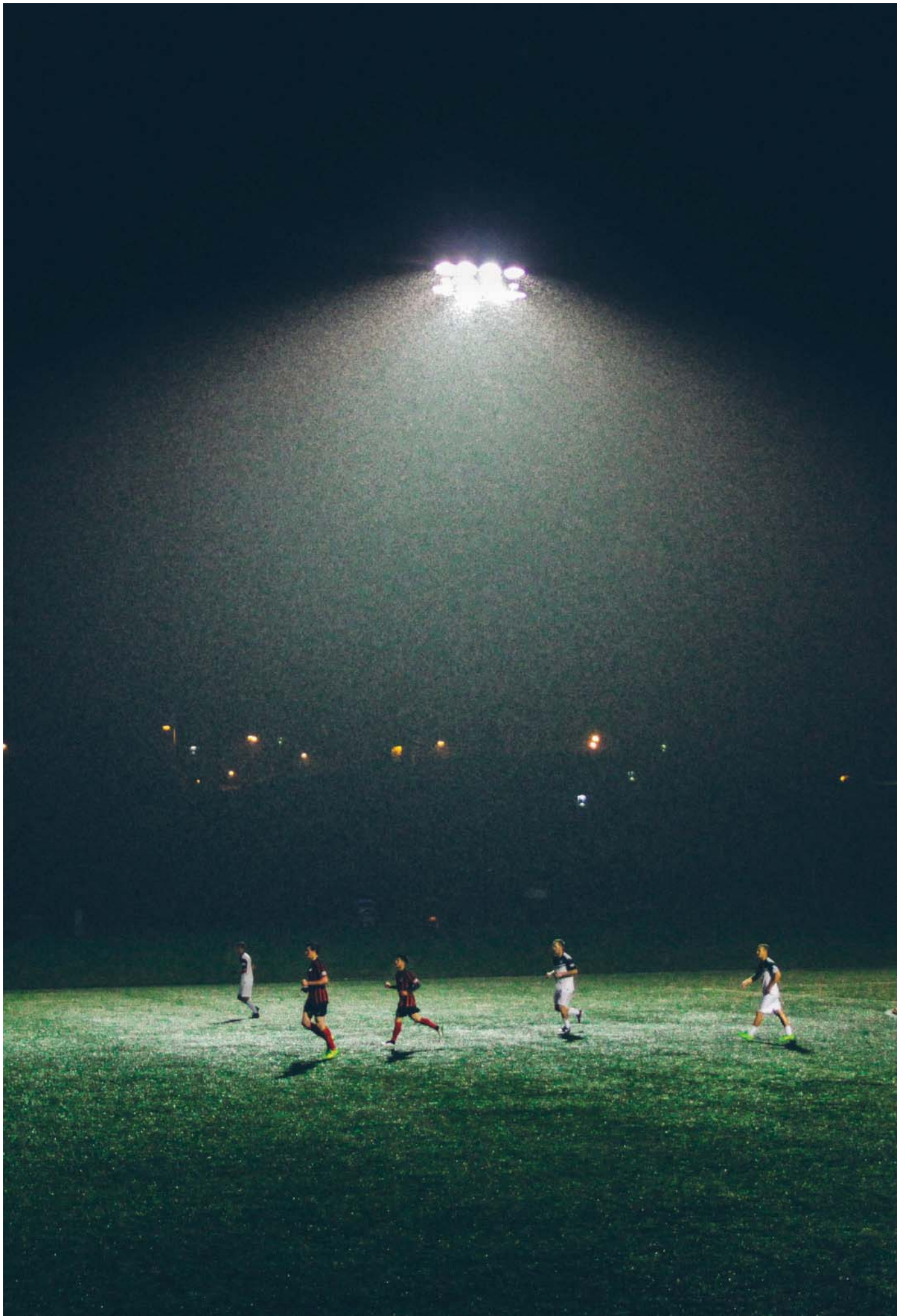



GARANTÍA
3 AÑOS



Ref	Lm	Vatios	Acabado	Dimensión	Material	Temperatura de color	PREZZO IVA escl.
LM6601	1800	18	Gris	1010X41X30H mm	Aluminio	6000K	59,90
LM6602	1800	18	Gris	1010X41X30H mm	Aluminio	4500K	59,90
LM6603	1800	18	Gris	1010X41X30H mm	Aluminio	3000K	59,90

conf. scat.

1 pz	20 pz	IP65	30000 H	DC 24V	30°	CRI 85	Max enlazable 10 und
------	-------	------	---------	--------	-----	--------	----------------------



Iluminación Exterior / Projectores Modulares LED

M Foco Modular Led Coliseo



GARANTÍA
5 AÑOS

Ref	Lm	Vatios	Acabado	Dimensión	Material	Temperatura de color	PREZZO IVAescl.
LM6201	37500	250	Negro	397X114X237H mm	Aluminio	6000K	576,00



Accesorios



Convertor a Dali
LF-SCD010B

conf.

1 pz	IP65	30000 H	AC 170 240V	IK8	60°	- 30°C + 50°C	CRI 70	F.P 0.95	KV 4	Regulable 1-10V
------	------	---------	----------------	-----	-----	------------------	-----------	-------------	---------	--------------------

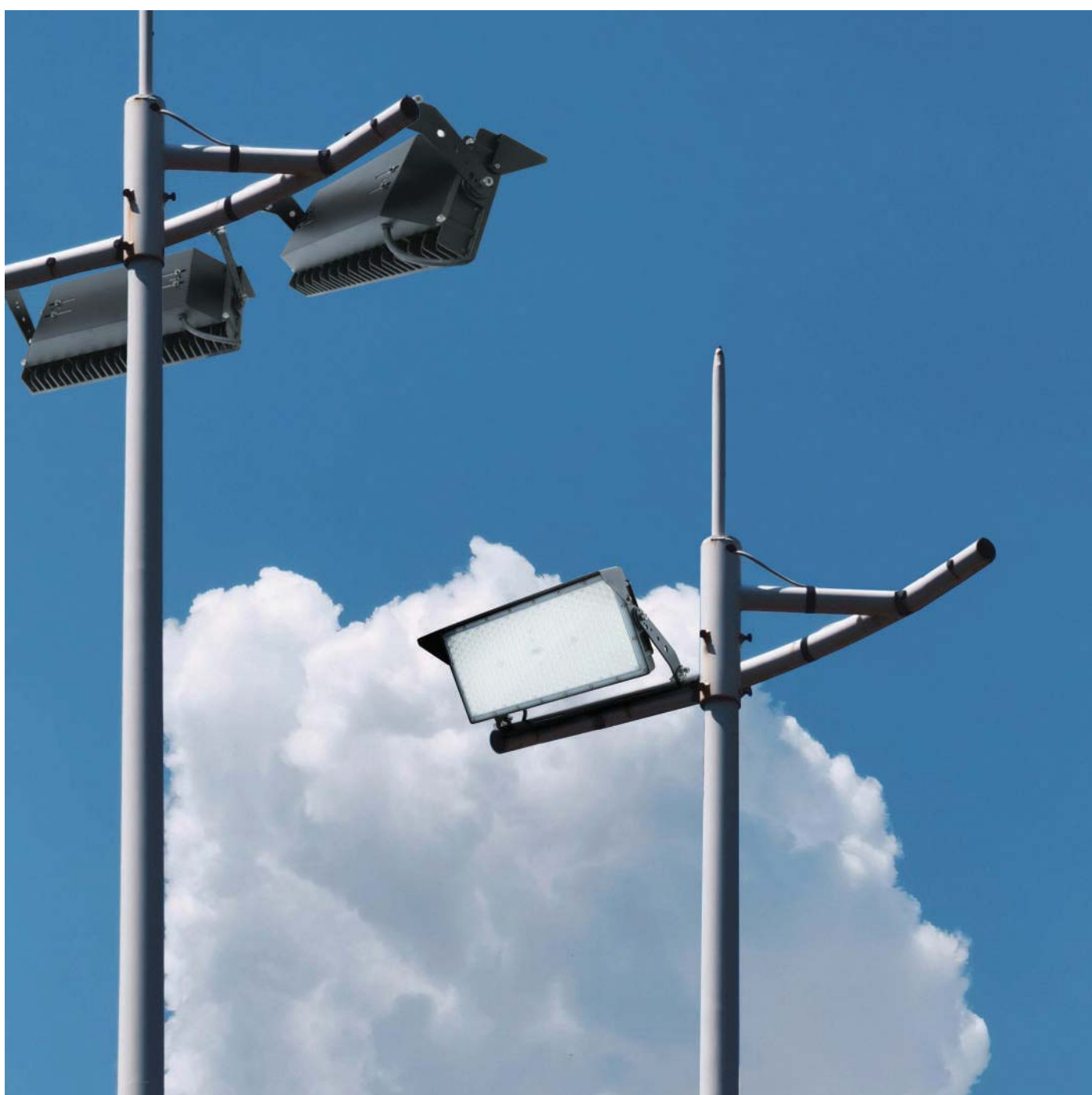

Iluminación Exterior / Projectores Modulares LED

M Foco Modular LED Coliseum



GARANTÍA 5 AÑOS



Ref	Lm	Vatios	Acabado	Dimensión	Material	Temperatura de color	PREZZO IVAescl.
LM6480	50000	400	Gris	370X140X495H mm	Aluminio / PMMA	6000K	667,00
LM6483	50000	400	Gris	370X140X495H mm	Aluminio / PMMA	4000K	667,00
LM6481	62500	500	Gris	440X140X495H mm	Aluminio / PMMA	6000K	892,00
LM6485	62500	500	Gris	440X140X495H mm	Aluminio / PMMA	4000K	892,00
LM6482	75000	600	Gris	495X140X540H mm	Aluminio / PMMA	6000K	1.155,00

Accesorios



Convertor a Dali LF-SCD010B

conf.

1 pz	IP65	50000 H	AC 90 265V	IK8	60°	F.P 0.90	- 40°C + 65°C	CRI 70	F.P 0.90	KV 6	Regulable 1-10V
------	------	---------	------------	-----	-----	----------	---------------	--------	----------	------	-----------------

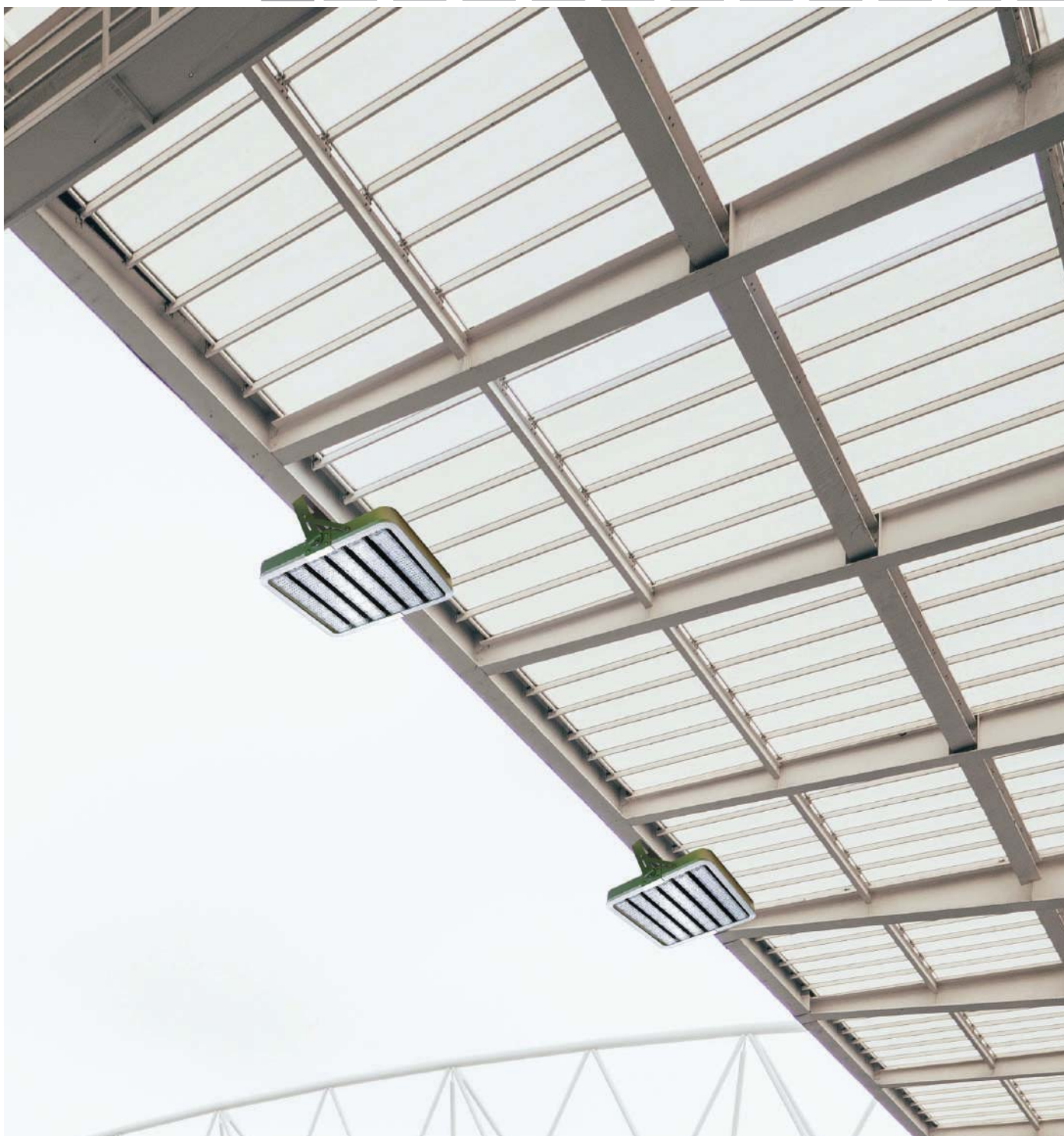

Iluminación Exterior / Proyectores Modulares LED

M Foco Modular LED Stadium



Ref	Lm	Vatios	Acabado	Dimensión	Material	Temperatura de color	PREZZO IVA escl.
LM6212	75000	500	Negro	440X155X470H mm	Aluminio	6000K	1.205,00
LM6214	112500	750	Negro	440X155X640H mm	Aluminio	6000K	1.658,00
LM6216	150000	1000	Negro	440X155X825H mm	Aluminio	6000K	2.237,00

conf.

1 pz	IP65	50000 H	AC 100 240V	IK8	25°	- 30°C + 50°C	CRI 75	F.P 0.95	KV 6	Regulable 1-10V
------	------	---------	-------------	-----	-----	---------------	--------	----------	------	-----------------

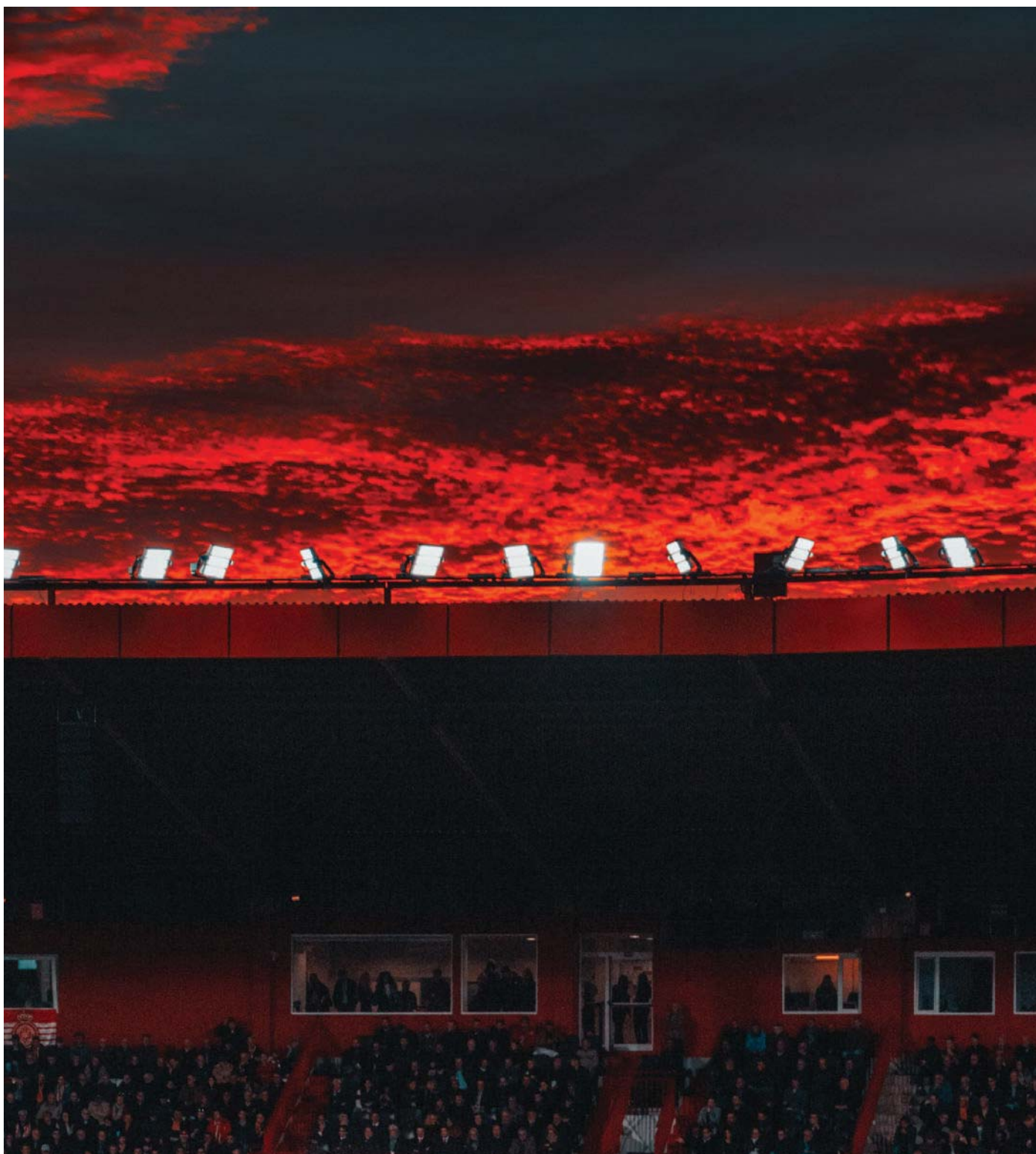

Iluminación Exterior / Projectores Modulares LED

M Foco Modular LED Premium



GARANTÍA
3 AÑOS



Ref	Lm	Vatios	Acabado	Dimensión	Material	Temperatura de color	PREZZO IVA escl.
LM6240	12000	100	Gris	205X305X120H mm	Aluminio / PMMA	5000K	149,00
LM6241	12000	100	Gris	205X305X120H mm	Aluminio / PMMA	4000K	149,00
LM6242	18000	150	Gris	270X360X120H mm	Aluminio / PMMA	5000K	205,00
LM6243	18000	150	Gris	270X360X120H mm	Aluminio / PMMA	4000K	205,00
LM6244	24000	200	Gris	360X360X135H mm	Aluminio / PMMA	5000K	259,00
LM6245	24000	200	Gris	360X360X135H mm	Aluminio / PMMA	4000K	259,00
LM6246	30000	250	Gris	460X360X135H mm	Aluminio / PMMA	5000K	305,00
LM6247	30000	250	Gris	460X360X135H mm	Aluminio / PMMA	4000K	305,00

1 pz

IP65

50000 H

AC 100
265

IK10

90°

- 30°C
+ 50°C

CRI
80

F.P
0.90

conf.





Accesorio para
Foco Modular Premium

Ref	Potencia maxima	Dimensión	Material	PREZZO VA esd.
LM2105	50	105X63X30H mm	Aluminio	0,00
LM2281	100	140X60X32H mm	Aluminio	0,00
LM2282	150	180X60X35H mm	Aluminio	0,00
LM2283	200	199X63X35,5H mm	Aluminio	0,00

conf. scatol.

1 pz

20 pz

IP67

AC 100
305V

- 40°C
+ 90°C

F.P
0.95





ILUMINACIÓN COMERCIAL

Iluminación Comercial / Cartelería LED

M Cadena de 20 Módulos de 1 LED SMD 3030 Osram



GARANTÍA
3 AÑOS



Ref	Lm	Vatios	Acabado	Dimensión	Material	Temperatura de color	PREZZO IVA escl.
LM6231	150	1.5	Blanco	49X31 mm	PC	6000 K	0,00

conf. scatol.

1 pz	5 pz	IP65	50000 H	DC 12V	160°	CRI 80
------	------	------	---------	--------	------	--------

Iluminación Comercial / Cartelería LED

M Cadena de 20 Módulos de 3 LED SMD 5730



GARANTÍA
3 AÑOS



Ref	Lm	Vatios	Acabado	Dimensión	Material	Temperatura de color	PREZZO IVA escl.
LM6236	60	0.75	Blanco	78X13 mm	PC	6000 K	0,00

conf. scatol.

1 pz	10 pz	IP65	50000 H	DC 12V	120°	CRI 80
------	-------	------	---------	--------	------	--------

Iluminación Comercial / Cartelería LED

M Cadena de 20 Módulos de 3 LED SMD 2835



GARANTÍA
3 AÑOS



Ref	Lm	Vatios	Acabado	Dimensión	Material	Temperatura de color	PREZZO IVA escl.
LM6233	140	1.5	Blanco	85X18 mm	PC	6000 K	0,00

conf. scatol.

1 pz	10 pz	IP65	50000 H	DC 12V	160°	CRI 80
------	-------	------	---------	--------	------	--------

Iluminación Comercial / Cartelería LED

M Cadena de 20 Módulos de 1 LED SMD 3030



GARANTÍA
3 AÑOS



Ref	Lm	Vatios	Acabado	Dimensión	Material	Temperatura de color	PREZZO IVA escl.
LM6235	150	1.5	Blanco	49X31 mm	PC	6000 K	0,00

conf. scatol.

1 pz	10 pz	IP65	50000 H	DC 12V	55°	CRI 80
------	-------	------	---------	--------	-----	--------

Iluminación Comercial / Cartelería LED

M Cadena de 20 Módulos de 1 LED Cob



GARANTÍA
3 AÑOS



Ref	Lm	Vatios	Acabado	Dimensión	Material	Temperatura de color	PREZZO IVA escl.
LM6232	190	2	Blanco	70X19 mm	PC	6000 K	0,00

conf. scatol.

1 pz	10 pz	IP65	50000 H	DC 12V	160°	CRI 80
------	-------	------	---------	--------	------	--------

Iluminación Comercial / Cartelería LED

M Cadena de 20 Módulos de 3 LED SMD 5730



GARANTÍA
3 AÑOS



Ref	Lm	Vatios	Acabado	Dimensión	Material	Temperatura de color	PREZZO IVA escl.
LM6234	110	1.2	Blanco	67X16 mm	PC	6000 K	0,00

conf. scatol.

1 pz	10 pz	IP65	50000 H	DC 12V	160°	CRI 80
------	-------	------	---------	--------	------	--------

Iluminación Comercial / Focos de Carril LED / Focos de Carril Led Monofásicos

M Foco LED 30W Para Carril Clean Monofásico



GARANTÍA
3 AÑOS



Ref	Lm	Vatios	Acabado	Dimensión	Material	Temperatura de color	PREZZO IVA escl.
LM3163	3000	30	Blanco	160X170H mm	Aluminio	CCT	42,00
LM3164	3000	30	Negro	160X170H mm	Aluminio	CCT	42,00

conf. scatol.

1 pz	20 pz	IP40	30000 H	AC 160 240V	Lente Dual 24-60°	- 20°C + 45°C	CRI 80	F.P 0.95
------	-------	------	---------	-------------	-------------------	---------------	--------	----------

Iluminación Comercial / Focos de Carril LED / Focos de Carril Led Monofásicos

M Foco LED Prolux Para Carril Monofásico 40W



GARANTÍA
5 AÑOS



Ref	Lm	Vatios	Acabado	Dimensión	Material	Temperatura de color	PREZZO IVA escl.
LM3172	4400	40	Negro	135X210H mm	Aluminio	4500 K	58,90
LM3173	4400	40	Negro	135X210H mm	Aluminio	3000 K	58,90
LM3175	4400	40	Blanco	135X210H mm	Aluminio	4500 K	58,90
LM3176	4400	40	Blanco	135X210H mm	Aluminio	3000 K	58,90

conf. scatol.

1 pz	12 pz	IP20	30000 H	AC 170 265V	60°	- 20°C + 45°C	CRI 90	F.P 0.90
------	-------	------	---------	-------------	-----	---------------	--------	----------

Iluminación Comercial / Focos de Carril LED / Focos de Carril Led Monofásicos

M Foco Led Fast 30W Para Carril Monofásico



GARANTÍA
3 AÑOS



Ref	Lm	Vatios	Acabado	Dimensión	Material	Temperatura de color	PREZZO IVA escl.
LM3141	3000	30	Negro	160X155H mm	Aluminio	6000 K	26,90
LM3142	3000	30	Negro	160X155H mm	Aluminio	4500 K	26,90
LM3143	3000	30	Negro	160X155H mm	Aluminio	3000 K	26,90
LM3144	3000	30	Blanco	160X155H mm	Aluminio	6000 K	14,90
LM3145	3000	30	Blanco	160X155H mm	Aluminio	4500 K	14,90
LM3146	3000	30	Blanco	160X155H mm	Aluminio	3000 K	14,90

1 pz 20 pz IP20 30000 H AC 170 240V 24° CRI 80 F.P 0.95
conf. scatol.

Iluminación Comercial / Focos de Carril LED / Focos de Carril Led Monofásicos

M Foco LED Berna 12W Para Carril Monofásico



GARANTÍA
3 AÑOS



Ref	Lm	Vatios	Acabado	Dimensión	Material	Temperatura de color	PREZZO IVA escl.
LM3105	1200	12	Blanco	140X135H mm	Aluminio	6000 K	14,90
LM3106	1200	12	Blanco	140X135H mm	Aluminio	4500 K	14,90
LM3107	1200	12	Blanco	140X135H mm	Aluminio	3000 K	14,90
LM3108	1200	12	Negro	140X135H mm	Aluminio	6000 K	14,90
LM3109	1200	12	Negro	140X135H mm	Aluminio	4500 K	14,90
LM3110	1200	12	Negro	140X135H mm	Aluminio	3000 K	14,90

1 pz 40 pz IP20 30000 H AC 85 265V 24° CRI 80 F.P 0.95
conf. scatol.

Iluminación Comercial / Focos de Carril LED / Focos de Carril Led Monofásicos

M Foco Para Carril GU10 City

GARANTÍA
3 AÑOS



Ref	Acabado	Dimensión	Material	PREZZO IVA escl.
LM4353	Blanco	105X70X137H mm	Metal	16,80

conf. scatol.
1 pz 20 pz GU10 IP20

Iluminación Comercial / Focos de Carril LED / Focos de Carril Led Monofásicos

M Foco GU10 Para Carril State

GARANTÍA
3 AÑOS



Ref	Acabado	Dimensión	Material	PREZZO IVA escl.
LM4356	Blanco	105X70X137H mm	Metal	16,80

conf. scatol.
1 pz 20 pz GU10 IP20

Iluminación Comercial / Focos de Carril LED / Focos de Carril Led Monofásicos

M Foco Led Para Carril Aras 30W Monofásico CCT



GARANTÍA
3 AÑOS



Ref	Lm	Vatios	Acabado	Dimensión	Material	Temperatura de color	PREZZO IVAescl.
LM3161	3000	30	Blanco	85X95X285H mm	Aluminio	CCT	37,90
LM3162	3000	30	Negro	85X95X285H mm	Aluminio	CCT	37,90

conf. scatol.

1 pz	20 pz	IP20	30000 H	AC 170 265V	36°	- 20°C + 45°C	CRI 85	F.P 0.95
------	-------	------	---------	----------------	-----	------------------	-----------	-------------

Iluminación Comercial / Focos de Carril LED / Focos de Carril Led Monofásicos

M Foco Led Para Carril Promax 40W Monofásico



GARANTÍA
5 AÑOS



Ref	Lm	Vatios	Acabado	Dimensión	Material	Temperatura de color	PREZZO IVAescl.
LM5341	4400	40	Blanco	500X150H mm	Aluminio	6000 K	109,00
LM5342	4400	40	Blanco	500X150H mm	Aluminio	4500 K	109,00
LM5343	4400	40	Blanco	500X150H mm	Aluminio	3000 K	109,00
LM5344	4400	40	Negro	500X150H mm	Aluminio	6000 K	109,00
LM5345	4400	40	Negro	500X150H mm	Aluminio	4500 K	109,00
LM5346	4400	40	Negro	500X150H mm	Aluminio	3000 K	109,00

1 pz	10 pz	IP20	30000 H	AC 80 265V	120°	- 30°C + 45°C	CRI 80	F.P 0.95	KV 4
------	-------	------	---------	---------------	------	------------------	-----------	-------------	---------

conf. scatol.



Iluminación Comercial / Focos de Carril LED / Focos de Carril Led Monofásicos

M Foco portalámparas E27 Para Carril Movie Monofásico

GARANTÍA
3 AÑOS



Ref	Acabado	Dimensión	Material	PREZZO IVAescl.
LM4344	Negro	170X380H mm	Metal	49,90

conf.	scatol.	IP20	Pot max 40
1 pz	12 pz		

Iluminación Comercial / Focos de Carril LED / Focos de Carril Led Monofásicos

M Foco portalámparas GU10 Para Carril Movie Monofásico

GARANTÍA
3 AÑOS



Ref	Acabado	Dimensión	Material	PREZZO IVAescl.
LM4342	Negro	90X240H mm	Metal	23,00

conf.	scatol.	IP20	Pot max 40
1 pz	30 pz		



Iluminación Comercial / Focos de Carril LED / Focos de Carril Led Monofásicos

M Conector en L Para Carril Monofásico

GARANTÍA
3 AÑOS



Ref	Acabado	Dimensión	Material	PREZZO IVA escl.
LM3252	Blanco	109X109X17H mm	PC	4,10
LM3255	Negro	109X109X17H mm	PC	4,10

conf.	scatol.	
1 pz	100 pz	IP20

Iluminación Comercial / Focos de Carril LED / Focos de Carril Led Monofásicos

M Conector en T Para Carril Monofásico

GARANTÍA
3 AÑOS



Ref	Acabado	Dimensión	Material	PREZZO IVA escl.
LM3253	Blanco	109X55X17H mm	PC	6,10
LM3256	Negro	109X55X17H mm	PC	6,10

conf.	scatol.	
1 pz	100 pz	IP20

Iluminación Comercial / Focos de Carril LED / Focos de Carril Led Monofásicos

M Conector I Reforzado Para Carril Monofásico

GARANTÍA
3 AÑOS



Ref	Acabado	Dimensión	Material	PREZZO IVA escl.
LM3251	Blanco	77X30X17H mm	PC	5,00
LM3254	Negro	77X30X17H mm	PC	5,00

conf.	scatol.	
1 pz	100 pz	IP20

Iluminación Comercial / Focos de Carril LED / Focos de Carril Led Monofásicos

M Base empotrable con carril Blanco Monofásico

GARANTÍA
3 AÑOS



Ref	Acabado	Dimensión	Material	PREZZO IVA escl.
LM3262	Blanco	170X30H mm	PC	6,50

conf.	scatol.	
1 pz	10 pz	Corte 150 mm



Iluminación Comercial / Focos de Carril LED / Focos de Carril Led Monofásicos

Base de Superficie con carril Blanco Monofásico

GARANTÍA
3 AÑOS



Ref	Acabado	Dimensión	Material	PREZZO IVA escl.
LM3261	Blanco	189X55X20H mm	PC	4,90

conf. scatol.

1 pz

20 pz

IP20



Iluminación Comercial / Focos de Carril LED / Focos de Carril Led Monofásicos

Carril Monofásico Reforzado

GARANTÍA
3 AÑOS



Ref	Acabado	Dimensión	Material	PREZZO IVA escl.
LM3201	Blanco	1000X40X20H mm	Aluminio	9,90
LM3206	Negro	1000X40X20H mm	Aluminio	9,90
LM3203	Blanco	2000X40X20H mm	Aluminio	19,90
LM3204	Negro	2000X40X20H mm	Aluminio	19,90

conf. scatol.

1 pz

20 pz

IP20

Pot max
250



Iluminación Comercial / Focos de Carril LED / Focos de Carril Led Trifásicos

Foco Led Turin Para Carril Trifásico



GARANTÍA
3 AÑOS



Ref	Lm	Vatios	Acabado	Dimensión	Material	Temperatur de color	PREZZO IVA escl.
LM3147	2680	30	Negro	150X169H mm	Aluminio / PC	6000 K	49,90
LM3148	2680	30	Negro	150X169H mm	Aluminio / PC	4500 K	49,90
LM3149	2680	30	Negro	150X169H mm	Aluminio / PC	3000 K	49,90
LM3150	2680	30	Blanco	150X169H mm	Aluminio / PC	6000 K	49,90
LM3151	2680	30	Blanco	150X169H mm	Aluminio / PC	6000 K	49,90
LM3152	2680	30	Blanco	150X169H mm	Aluminio / PC	6000 K	49,90

1 pz

20 pz

IP20

30000 H

AC 170
240V

24°

CRI
90

F.P
0.95

conf. scatol.



Iluminación Comercial / Focos de Carril LED / Focos de Carril Led Trifásicos

M Foco LED Lepsie Para carril Trifásico No Flicker



GARANTÍA
5 AÑOS



Ref	Lm	Vatios	Acabado	Dimensión	Material	Temperatur de color	PREZZO IVAescl.
LM3101	3520	32	Blanco	230X70X250H mm	Aluminio / PC	6000 K	96,90
LM3102	3520	32	Blanco	230X70X250H mm	Aluminio / PC	4500 K	96,90
LM3103	3520	32	Blanco	230X70X250H mm	Aluminio / PC	3000 K	96,90

conf. scatol.

1 pz	20 pz	IP20	50000 H	AC 85 265V	36°	CRI 85	F.P 0.95
------	-------	------	---------	---------------	-----	-----------	-------------

Iluminación Comercial / Focos de Carril LED / Focos de Carril Led Trifásicos

M Foco LED Milan 30W Para Carril Trifásico



GARANTÍA
5 AÑOS



Ref	Lm	Vatios	Acabado	Dimensión	Material	Temperatura de color	PREZZO IVAescl.
LM3119	2700	30	Negro	230X80X18H mm	Aluminio / PC	6000 K	56,90
LM3120	2700	30	Negro	230X80X18H mm	Aluminio / PC	4500 K	56,90
LM3121	2700	30	Negro	230X80X18H mm	Aluminio / PC	3000 K	56,90

conf. scatol.

1 pz	12 pz	IP20	30000 H	AC 85 265V	36°	CRI 90	F.P 0.95
------	-------	------	---------	---------------	-----	-----------	-------------

Iluminación Comercial / Focos de Carril LED / Focos de Carril Led Trifásicos

M Base Promax Negro Para Carril Trifásico

GARANTÍA
3 AÑOS



Ref	Acabado	Dimensión	PREZZO IVAescl.
LM5347	Blanco	205X45X60H mm	12,00
LM5348	Negro	205X45X60H mm	12,00

conf. scatol.

1 pz	15 pz	IP20
------	-------	------

Iluminación Comercial / Focos de Carril LED / Focos de Carril Led Trifásicos

M Conector Flexible Para Carril Trifásico

GARANTÍA
3 AÑOS



Ref	Acabado	Dimensión	Material	PREZZO IVAescl.
LM3225	Blanco	240X30X35 mm	PC	22,90
LM3226	Negro	240X30X35 mm	PC	22,90

conf. scatol.

1 pz	50 pz	IP20
------	-------	------

M

Iluminación Comercial / Focos de Carril LED / Focos de Carril Led Trifásicos

Conector y Tapón Para Carril Trifásico

GARANTÍA
3 AÑOS

Ref	Acabado	Dimensión	Material	PREZZO IVA escl.
LM3224	Blanco	100X30X33H mm	Aluminio / PC	7,20
LM3223	Negro	100X30X33H mm	Aluminio / PC	7,20

conf.	scatol.	
2 pz	100 pz	IP20

M

Iluminación Comercial / Focos de Carril LED / Focos de Carril Led Trifásicos

Conector Tipo X Para Carril Trifásico

GARANTÍA
3 AÑOS

Ref	Acabado	Dimensión	Material	PREZZO IVA escl.
LM3215	Blanco	165X165X33H mm	Aluminio / PC	22,50

conf.	scatol.	
1 pz	50 pz	IP20

M

Iluminación Comercial / Focos de Carril LED / Focos de Carril Led Trifásicos

Conector en línea Para Carril Trifásico

GARANTÍA
3 AÑOS

Ref	Acabado	Dimensión	Material	PREZZO IVA escl.
LM3221	Blanco	70X30X27H mm	PC	6,20
LM3222	Negro	70X30X27H mm	PC	6,20

conf.	scatol.	
1 pz	100 pz	IP20

M

Iluminación Comercial / Focos de Carril LED / Focos de Carril Led Trifásicos

Conector con separador en línea Para Carril Trifásico

GARANTÍA
3 AÑOS

Ref	Acabado	Dimensión	Material	PREZZO IVA escl.
LM3210	Blanco	165X33X33H mm	Aluminio	10,20
LM3216	Negro	165X33X33H mm	Aluminio	10,20

conf.	scatol.	
2 pz	100 pz	IP20

M Conector tipo L Para Carril Trifásico

GARANTÍA
3 AÑOS



Ref	Acabado	Dimensión	Material	PREZZO IVA escl.
LM3213	Blanco	97X97X20H mm	Aluminio / PC	12,50
LM3217	Negro	97X97X20H mm	Aluminio / PC	12,50

conf.	scatol.	
1 pz	40 pz	IP20

M Conector tipo T Para Carril Trifásico

GARANTÍA
3 AÑOS



Ref	Acabado	Dimensión	Material	PREZZO IVA escl.
LM3214	Blanco	165X98X32H mm	Aluminio	17,50
LM3218	Negro	165X98X32H mm	Aluminio	17,50

conf.	scatol.	
1 pz	50 pz	IP20

M Carril Trifásico 2 metros

GARANTÍA
3 AÑOS



Ref	Acabado	Dimensión	Material	PREZZO IVA escl.
LM3209	Blanco	2000X32X36H mm	Aluminio	57,50
LM3220	Negro	2000X32X36H mm	Aluminio	57,50

conf.	scatol.		
1 pz	10 pz	IP20	Pot max 2500

Iluminación Comercial / Focos de Carril LED / Focos de Carril Led Magnéticos

M Foco LED Detail Plus Para Carril Magnético Negro 48V



GARANTÍA
3 AÑOS



Ref	Lm	Vatios	Acabado	Dimensión	Material	Temperatura de color	PREZZO IVA escl.
LM3571	1000	10	Negro	40X300H mm	Aluminio	4000 K	51,60
LM3621	1000	10	Negro	40X300H mm	Aluminio	3000 K	51,60
LM3572	1000	10	Blanco	40X300H mm	Aluminio	4000 K	51,60
LM3622	1000	10	Blanco	40X300H mm	Aluminio	3000 K	51,60

conf. scatol.

1 pz	20 pz	IP20	30000 H	DC 48V	36°	- 20°C + 45°C	CRI 90	F.P 0.95	UGR 17
------	-------	------	---------	--------	-----	------------------	--------	----------	--------

Iluminación Comercial / Focos de Carril LED / Focos de Carril Led Magnéticos

M Foco LED Hallway Detail Para carril Magnético 48V



GARANTÍA
3 AÑOS



Ref	Lm	Vatios	Acabado	Dimensión	Material	Temperatura de color	PREZZO IVA escl.
LM3555	1200	12	Negro	283X17X22H mm	Aluminio	4000 K	14,90
LM3605	1200	12	Negro	283X17X22H mm	Aluminio	3000 K	14,90
LM3557	1800	18	Negro	396X17X22H mm	Aluminio	4000 K	17,90
LM3607	1800	18	Negro	396X17X22H mm	Aluminio	3000 K	17,90
LM3559	2400	24	Negro	511X17X22H mm	Aluminio	4000 K	22,90
LM3609	2400	24	Negro	511X17X22H mm	Aluminio	3000 K	22,90
LM3556	1200	12	Blanco	283X17X22H mm	Aluminio	4000 K	14,90
LM3606	1200	12	Blanco	283X17X22H mm	Aluminio	3000 K	14,90
LM3558	1800	18	Blanco	396X17X22H mm	Aluminio	4000 K	17,90
LM3608	1800	18	Blanco	396X17X22H mm	Aluminio	3000 K	17,90
LM3558	2400	24	Blanco	511X17X22H mm	Aluminio	4000 K	22,90
LM3608	2400	24	Blanco	511X17X22H mm	Aluminio	3000 K	22,90

conf. scatol.

1 pz	50 pz	IP20	30000 H	DC 48V	36°	- 20°C + 45°C	CRI 90	F.P 0.95	UGR 17
------	-------	------	---------	--------	-----	------------------	--------	----------	--------

Iluminación Comercial / Focos de Carril LED / Focos de Carril Led Magnéticos

M Foco LED Lounge Detail Para carril Magnético 48V



GARANTÍA
3 AÑOS



Ref	Lm	Vatios	Acabado	Dimensión	Material	Temperatura de color	PREZZO IVA escl.
LM3551	1000	10	Negro	355X17X22H mm	Aluminio	4000 K	14,60
LM3601	1000	10	Negro	355X17X22H mm	Aluminio	3000 K	14,60
LM3553	2000	20	Negro	655X17X22H mm	Aluminio	4000 K	21,90
LM3603	2000	20	Negro	655X17X22H mm	Aluminio	3000 K	21,90
LM3552	1000	10	Blanco	355X17X22H mm	Aluminio	4000 K	14,60
LM3602	1000	10	Blanco	355X17X22H mm	Aluminio	3000 K	14,60
LM3554	2000	20	Blanco	655X17X22H mm	Aluminio	4000 K	21,90
LM3604	2000	20	Blanco	655X17X22H mm	Aluminio	3000 K	21,90

1 pz	50 pz	IP20	30000 H	DC 48V	120°	- 20°C + 45°C	CRI 90	F.P 0.95	UGR 19
------	-------	------	---------	--------	------	------------------	--------	----------	--------

conf. scatol.

Iluminación Comercial / Focos de Carril LED / Focos de Carril Led Magnéticos

M Foco LED Linéaire Detail Para carril Magnético 48V



GARANTÍA
3 AÑOS



Ref	Lm	Vatios	Acabado	Dimensión	Material	Temperatura de color	PREZZO IVA escl.
LM3561	600	6	Negro	125X75H mm	Aluminio	4000 K	23,80
LM3611	600	6	Negro	125X75H mm	Aluminio	3000 K	23,80
LM3563	1200	12	Negro	245X60H mm	Aluminio	4000 K	32,90
LM3613	1200	12	Negro	245X60H mm	Aluminio	3000 K	32,90
LM3562	600	6	Blanco	125X75H mm	Aluminio	4000 K	23,80
LM3612	600	6	Blanco	125X75H mm	Aluminio	4000 K	23,80
LM3564	1200	12	Blanco	245X60H mm	Aluminio	4000 K	32,90
LM3614	1200	12	Blanco	245X60H mm	Aluminio	4000 K	32,90

1 pz	40 pz	IP20	30000 H	DC 48V	36°	- 20°C + 45°C	CRI 90	F.P 0.95	UGR 17
------	-------	------	---------	--------	-----	------------------	--------	----------	--------

conf. scatol.

Iluminación Comercial / Focos de Carril LED / Focos de Carril Led Magnéticos

M Foco LED Detail Para carril Magnético 48V



GARANTÍA
3 AÑOS



Ref	Lm	Vatios	Acabado	Dimensión	Material	Temperatura de color	PREZZO IVA escl.
LM3565	700	7	Negro	115X100H mm	Aluminio	4000 K	30,00
LM3615	700	7	Negro	115X100H mm	Aluminio	3000 K	30,00
LM3567	1000	10	Negro	115X110H mm	Aluminio	4000 K	32,90
LM3617	1000	10	Negro	115X110H mm	Aluminio	3000 K	32,90
LM3569	2000	20	Negro	115X120H mm	Aluminio	4000 K	48,90
LM3619	2000	20	Negro	115X120H mm	Aluminio	3000 K	48,90
LM3566	700	7	Blanco	115X100H mm	Aluminio	4000 K	30,00
LM3616	700	7	Blanco	115X100H mm	Aluminio	3000 K	30,00
LM3568	1000	10	Blanco	115X110H mm	Aluminio	4000 K	32,90
LM3618	1000	10	Blanco	115X110H mm	Aluminio	3000 K	32,90
LM3570	2000	20	Blanco	115X120H mm	Aluminio	4000 K	48,90
LM3550	2000	20	Blanco	115X120H mm	Aluminio	3000 K	48,90

1 pz	30 pz	IP20	30000 H	DC 48V	36°	- 20°C + 45°C	CRI 90	F.P 0.95	UGR 17
------	-------	------	---------	--------	-----	------------------	--------	----------	--------

conf. scatol.

Iluminación Comercial / Focos de Carril LED / Focos de Carril Led Magnéticos

M Conexión con cable de inicio Para Carril Magnético

GARANTÍA
3 AÑOS



Ref	Acabado	Dimensión	Material	PREZZO IVA escl.
LM3579	Negro	98X18X18H mm	PC	6,40
LM3580	Blanco	98X18X18H mm	PC	6,40

conf. scatol.

1 pz	10 pz	IP20
------	-------	------



Iluminación Comercial / Focos de Carril LED / Focos de Carril Led Magnéticos

Driver 48V Para Carril Magnético Detail

GARANTÍA
3 AÑOS



Ref	Vatios	Acabado	Dimensión	Material	PREZZO IVA escl.
LM3584	100	Negro	285X18X18H mm	Aluminio	39,90
LM3585	100	Blanco	285X18X18H mm	Aluminio	39,90
LM3582	150	Negro	370X18X18H mm	Aluminio	51,90
LM3583	150	Blanco	370X18X18H mm	Aluminio	51,90

conf. scatol.

1 pz	30 pz	IP20	AC 220 240V	- 20°C + 45°C
------	-------	------	----------------	------------------



Iluminación Comercial / Focos de Carril LED / Focos de Carril Led Magnéticos

Conexión doble Para Carril Magnético

GARANTÍA
3 AÑOS



Ref	Acabado	Dimensión	Material	PREZZO IVA escl.
LM3581	Negro	370 X 18 X 18 H mm	PC	10,00

conf. scatol.

1 pz	20 pz	IP20
------	-------	------



Iluminación Comercial / Focos de Carril LED / Focos de Carril Led Magnéticos

Unión en L Horizontal Para Carril Magnético Detail

GARANTÍA
3 AÑOS



Ref	Acabado	Dimensión	Material	PREZZO IVA escl.
LM3590	Negro	94X25H mm	Aluminio	12,30
LM3591	Blanco	94X25H mm	Aluminio	12,30

conf. scatol.

1 pz	10 pz	IP20
------	-------	------



Iluminación Comercial / Focos de Carril LED / Focos de Carril Led Magnéticos

Unión en T Horizontal Para Carril Magnético Detail

GARANTÍA
3 AÑOS



Ref	Acabado	Dimensión	Material	PREZZO IVA escl.
LM3594	Negro	165X94X30H mm	Aluminio	24,90
LM3595	Blanco	165X94X30H mm	Aluminio	24,90

conf. scatol.

1 pz	10 pz	IP20
------	-------	------

M Unión en L Vertical Para Carril Magnético Detail

GARANTÍA
3 AÑOS



Ref	Acabado	Dimensión	Material	PREZZO IVA escl.
LM3592	Negro	94X30H mm	Aluminio	12,30
LM3593	Blanco	94X30H mm	Aluminio	12,30

conf.	scatol.
1 pz	10 pz IP20

M Unión en X Horizontal Para Carril Magnético Detail

GARANTÍA
3 AÑOS



Ref	Acabado	Dimensión	Material	PREZZO IVA escl.
LM3596	Negro	165X 165X30H mm	Aluminio	29,90
LM3597	Blanco	165X 165X30H mm	Aluminio	29,90

conf.	scatol.
1 pz	10 pz IP20







ESTILO MAGNÉTICO

Estilo y luz.

Flexibles y sutiles a la vez, precisos y tan creativos como tú.

Iluminación rediseñada y elegantemente refinada.

Iluminación Comercial / Focos de Carril LED / Focos de Carril Led Magnéticos

M Carril Magnético de empotrar Detail

GARANTÍA
3 AÑOS



Ref	Acabado	Dimensión	Material	PREZZO IVA escl.
LM3577	Negro	2000X36,9X29H mm	Aluminio	47,00
LM3578	Blanco	2000X36,9X29H mm	Aluminio	47,00

Accesorios



Union
LM3599
Colgadores
LM3598

Grapa
KB3575

1 pz 10 pz IP20
conf. scatol.

GARANTÍA
3 AÑOS

Iluminación Comercial / Focos de Carril LED / Focos de Carril Led Magnéticos

M Carril Magnético Detail



Ref	Acabado	Dimensión	Material	PREZZO IVA escl.
LM3575	Negro	2000X27X29H mm	Aluminio	52,90
LM3576	Blanco	2000X27X29H mm	Aluminio	52,90

Accesorios



Union
LM3599
Colgadores
LM3598

1 pz 12 pz IP20
conf. scatol.

Iluminación Comercial / Iluminación Decorativa / Lámparas de techo LED / Iluminación LED Acentuación

M Lámpara lineal LED Viena 40W (UGR 17)



GARANTÍA
5 AÑOS



Ref	Lm	Vatios	Acabado	Dimensión	Material	Temperatura de color	PREZZO IVA escl.
LM3409	4800	40	Negro	1070X34X60H mm	Aluminio	4500 K	118,00
LM3410	4800	40	Negro	1070X34X60H mm	Aluminio	3000 K	118,00

conf. scatol.

1 pz 10 pz IP20 30000 H AC 170 265V 30° CRI 90 F.P 0.90 UGR 17

Iluminación Comercial / Iluminación Decorativa / Lámparas de techo LED / Iluminación LED Acentuación

M Lámpara lineal LED Vision 30W



GARANTÍA
5 AÑOS



Ref	Lm	Vatios	Acabado	Dimensión	Material	Temperatura de color	PREZZO IVA escl.
LM3415	3600	30	Negro	1125X20X70H mm	Aluminio	4500 K	88,00
LM3416	3600	30	Negro	1125X20X70H mm	Aluminio	3000 K	88,00

conf. scatol.

2 pz 10 pz IP20 30000 H AC 170 265V CRI 90 F.P 0.90 UGR 19

Iluminación Comercial / Iluminación Decorativa / Lámparas de techo LED / Iluminación LED Acentuación

M Lámpara lineal LED Viena II 40W (UGR 19)



GARANTÍA
5 AÑOS



Ref	Lm	Vatios	Acabado	Dimensión	Material	Temperatura de color	PREZZO IVA escl.
LM3412	4800	40	Negro	1070X34X60H mm	Aluminio	4500 K	118,00
LM3413	4800	40	Negro	1070X34X60H mm	Aluminio	3000 K	118,00

conf. scatol.

1 pz	10 pz	IP20	30000 H	AC 170 265V	CRI 90	F.P 0.90	UGR 19
------	-------	------	---------	----------------	-----------	-------------	-----------



Iluminación Comercial / Iluminación LED Acentuación
M **Módulo Led Cobfix 10W**



GARANTÍA
3 AÑOS



Ref	Lm	Vatios	Acabado	Dimensión	Material	Temperatura de color	PREZZO IVAescl.
LM4304	920	10	Negro	240X150X85H mm	Aluminio / PC	6000 K	19,90
LM4305	920	10	Negro	240X150X85H mm	Aluminio / PC	4500 K	19,90
LM4306	920	10	Negro	240X150X85H mm	Aluminio / PC	3000 K	19,90

Accesorios



Driver Triac
Lf-Gde014Yg

conf. scatol.

1 pz	100 pz	IP20	30000 H	AC 170 265V	24°	- 20°C + 45°C	CRI 80	F.P 0.60	UGR 19
------	--------	------	---------	----------------	-----	------------------	-----------	-------------	-----------



Plata
LM4381



Dorado
LM4382



Negro
LM4383



Blanco
LM4384

M Aros y Accesorios **Aro Empotrable Para Módulo Cobfix 10W**

GARANTÍA
3 AÑOS



Ref	Acabado	Dimensión	Dimensión de Corte	Material	PREZZO IVA escl.
LM4377	Blanco	85X25H mm	73 mm	Aluminio	5,50
LM4378	Negro	85X25H mm	73 mm	Aluminio	5,50

conf. scatoL.
1 pz 100 pz

M Aros y Accesorios **Aro de Superficie Para Módulo Cobfix 10W**

GARANTÍA
3 AÑOS



Ref	Acabado	Dimensión	Material	PREZZO IVA escl.
LM4369	Blanco	105X105X110mm	Aluminio	19,90
LM4373	Negro	105X105X110mm	Aluminio	19,90

conf. scatoL.
1 pz 20 pz

M Aros y Accesorios **Aro de Superficie 2L Para Módulo Cobfix 10W**

GARANTÍA
3 AÑOS



Ref	Acabado	Dimensión	Material	PREZZO IVA escl.
LM4370	Blanco	200X110X110H mm	Aluminio	34,90
LM4374	Negro	200X110X110H mm	Aluminio	34,90

conf. scatoL.
1 pz 12pz

M Aros y Accesorios **Aro de Superficie 3L Para Módulo Cobfix 10W**

GARANTÍA
3 AÑOS



Ref	Acabado	Dimensión	Material	PREZZO IVA escl.
LM4371	Blanco	295X110X110H mm	Aluminio	57,90
LM4375	Negro	295X110X110H mm	Aluminio	78,90

conf. scatoL.
1 pz 8 pz



Aros y Accesorios

Aro de Superficie 4L Para Módulo Cobfix 10W

GARANTÍA
3 AÑOS

Ref	Acabado	Dimensión	Material	PREZZO /A escl.
LM4372	Blanco	205X205X110H mm	Aluminio	78,90
LM4376	Negro	205X205X110H mm	Aluminio	78,90

conf. scatola.

1 pz

8 pz



Aros y Accesorios

Aro Empotrable para módulo Cobfix 10W

GARANTÍA
3 AÑOS

Ref	Acabado	Dimensión	Material	PREZZO /A escl.
LM4361	Blanco	83X83X27H mm	Aluminio	6,90
LM4365	Negro	83X83X27H mm	Aluminio	6,90

conf. scatola.

1 pz

60 pz



Aros y Accesorios

Aro Empotrable 2L para módulo Cobfix 10W

GARANTÍA
3 AÑOS

Ref	Acabado	Dimensión	Material	PREZZO /A escl.
LM4362	Blanco	83X83X27H mm	Aluminio	12,20
LM4366	Negro	167X87X27H mm	Aluminio	12,20

conf. scatola.

1 pz

30 pz



Aros y Accesorios

Aro Empotrable 3L para módulo Cobfix 10W

GARANTÍA
3 AÑOS

Ref	Acabado	Dimensión	Material	PREZZO /A escl.
LM4363	Blanco	83X83X27H mm	Aluminio	18,40
LM4367	Negro	247X87X27H mm	Aluminio	18,40

conf. scatola.

1 pz

30 pz

M Aros y Accesorios

Aro Empotrable 4L para módulo Cobfix 10W

GARANTÍA
3 AÑOS



Ref	Acabado	Dimensión	Material	PREZZO IVA escl.
LM4364	Blanco	166X166X27H mm	Aluminio	24,40
LM4368	Negro	166X166X27H mm	Aluminio	24,40

conf. scato.
1 pz 15 pz





Ref	Vatios	Acabado	Dimensión	Material	Temperatura de color	PREZIO IVA escl.
LM6622	28	Azul	240X260H mm	Aluminio	Azul (Pescados)	88,00
LM6623	28	Rojo	240X260H mm	Aluminio	Rojo (Carnes)	88,00
LM6624	28	Verde	240X260H mm	Aluminio	Verde (Verduras)	88,00

conf.

1 pz	IP20	30000 H	AC 160 240V	60°	CRI 97	F.P 0.96
------	------	---------	----------------	-----	-----------	-------------



PESCADERÍA

Las bancas de las pescaderías suelen ser extensas para dar cabida a pescados, mariscos o moluscos, todo el género fresco debe exponerse para que al cliente final se le haga la boca agua nada más verlos, por ello, llamar la atención con una luz debidamente proyectada es vital, la adaptabilidad de la iluminación que proporciona las ópticas de **Ledme-europa** permite que todo el producto iluminado, generalmente desde el techo, se vea espectacular.



CARNICERÍA

Crea un ambiente que invite a la compra, ya que es capaz de mostrar la mejor cara de los cárnicos ofrecidos, resaltando el color natural de éstos.

Para cada tipo de productos se debe tener una solución de iluminación de carnicerías que logre resaltar su atractivo. Aquí es donde entra en juego la variación cromática, siendo esta específica para cada uno de los productos cárnicos y sacando todo el provecho posible.



VERDULERÍA

El atractivo de la sección de productos frescos (más que cualquier otra) va a determinar muchísimo la imagen y el éxito del supermercado.

Una buena iluminación garantiza la buena visualización y conservación del producto además de correcta imagen de conjunto para el comercio que hace aumentar los ingresos procedentes de los productos frescos.

Iluminación Interior / Downlight LED / Iluminación Comercial / Iluminación LED Acentuación

M Downlight Proyector LED Track (UGR 19)



GARANTÍA 3 AÑOS



Ref	Lm	Vatios	Acabado	Corte	Dimensión	Material	Temperatura de color	PREZZO IVA escl.
LM4129	1500	15	Blanco	110 mm	113X90H mm	Aluminio / Cristal	6000 K	36,90
LM4130	1500	15	Blanco	110 mm	113X90H mm	Aluminio / Cristal	4500 K	36,90
LM4131	1500	15	Blanco	110 mm	113X90H mm	Aluminio / Cristal	3000 K	36,90
LM4132	3000	30	Blanco	150 mm	165X140H mm	Aluminio / Cristal	4500 K	49,40
LM4133	3000	30	Blanco	150 mm	165X140H mm	Aluminio / Cristal	3000 K	49,40
LM4134	3000	30	Blanco	150 mm	165X140H mm	Aluminio / Cristal	6000 K	49,40

Accesorios



1 pz conf.	IP20	30000 H	AC 85 265V	24°	- 20°C + 45°C	CRI 80	FP 0.88	UGR 19
---------------	------	---------	---------------	-----	------------------	-----------	------------	-----------





Iluminación Comercial / Iluminación LED Acentuación

Downlight Proyector LED Navi CCT



GARANTÍA
3 AÑOS



Ref	Lm	Vatios	Acaba- do	Corte	Dimensión	Material	Temperatura de color	PREZZO IVA escl.
LM3017	3600	36	Blanco	220X125 mm	240X150X85H mm	Aluminio / PC	CCT	51,90

conf. scatol.

1 pz	8 pz	IP20	40000 H	AC 170 265V	120°	- 20°C + 45°C	CRI 80	F.P 0.90	UGR 19
------	------	------	---------	----------------	------	------------------	-----------	-------------	-----------



● Temperatura
CCT

● Fuente lumínica
Lumileds



Ref	Vatios	Acabado	Dimensión	Material	Temperatura de color	PREZZO IVAescl.
LM3020	7,5	Negro / Transparente	330X80X244H mm	Aluminio / PC	6000 K	97,90
LM3021	10	Negro / Transparente	455X80X330H mm	Aluminio / PC	6000 K	138,90

conf. scatol.

1 pz 5 pz IP20 50000 H DC 12V

¿Cómo instalar Carpetas LED para Inmobiliarias en tu escaparate?

Diseñar escaparates con carpetas LED nunca ha sido más sencillo que ahora, déjate llevar por tu imaginación y crea el escaparate que deseas.

Tu escaparate es el eje principal, ese engranaje que permite un flujo continuo de información a tus clientes. Te permitirá seguir vendiendo cuando tu local esté cerrado.

Con nuestro kit de carteles LED de alta luminosidad y bajo consumo, se consigue un impacto visual y económico inmejorable, la información de tus clientes merece ser expuesta de la mejor manera con diseño versátil, eficaz y, sobre todo, a buen precio.

Podrás usar distintos tamaños de Carpetas LED, eligiendo entre los modelos A3 y A4, y así adaptar la publicidad a las necesidades de tu negocio.

Consigue calidad en tecnología LED, que permite ahorrar en costes, aun teniéndolos encendidos todo el día.

Contamos con algunos Kits de montajes que pueden ayudarte a facilitar mucho más la tarea, solo necesitas un poco de tiempo y tendrás lo que deseas de manera muy fácil.

Ejemplo Instalación de Carpeta LED para Inmobiliarias

Paso 1

Usaremos los colgadores como conductores para alimentar las carpetas led. Los soporte permiten pasar el cable si se presionan. Conectaremos estos a la fuente de alimentación de 12V.

Después sujetaremos los soportes al techo.

Paso 2

Comenzamos colocando el otro extremo del colgador a las carpetas y enlazaremos la segunda y tercera Carpeta LED mediante las uniones.

Hay que tener en cuenta que en las conexiones de las carpetas, viene marcado el positivo y el negativo, con lo cual debemos hacer coincidir todos los carteles que vayamos enlazando con la conexión que hicimos a la fuente de alimentación.

Paso 3

Conectaremos la fuente a la toma de corriente y las Carpetas LED comenzarán a iluminarse. Ya solo quedaría insertar la publicidad dentro de la carpeta, levantando la tapa que funciona mediante imanes.

Paso 4 (Opcional)

Aclaremos que la alimentación de las Carpetas LED se puede hacer tanto en la parte superior como inferior. Si deseamos realizarlo en la parte inferior, debemos, en la última Carpeta LED del paso 2, conectar los cables del kit de colgadores, sin usar los soportes. Ya que estos cables serán los que conectaremos a la fuente.

Hay que tener en cuenta que en las conexiones de las carpetas, viene marcado el positivo y el negativo, con lo cual debemos hacer coincidir el positivo y negativo de la fuente al positivo y negativo de esta última carpeta.

¿Se pueden instalar estas Carpetas LED en otros negocios?

Claro! Solo te hemos mostrado un ejemplo para instalar en inmobiliarias. Para los Cárteles LED pueden instalarse en negocios como: Concesionarios, Ventas o Alquiler de Vehículos

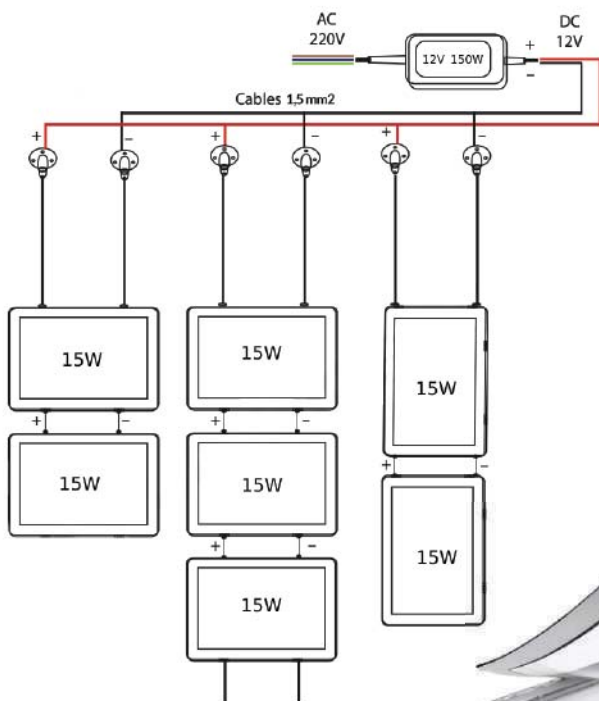



TIRAS LED

Tiras LED y Neón LED / Tiras LED 12V

M Tira de LED Videny 60 LED/m



GARANTÍA 3 AÑOS



Ref	IP	Vatios	Onda	Acabado	Dimensión	Material	Temperatura de color	PREZZO IVA escl.
LM2006	IP65	14 W/m	R-620-630 G-510-525 B-455-470 nm	PCB Blanco	10X5000 mm	PC	RGB	28,00
LM2015	IP20	14 W/m	R-620-630 G-510-525 B-455-470 nm	PCB Blanco	10X5000 mm	PC	RGB	21,00



conf. scatol.

1 pz	100 pz	Incluye Adhesivo	30000 H	DC 12V	120°	- 20°C + 45°C	CRI 80	Corte 5 cm
------	--------	------------------	---------	--------	------	------------------	--------	------------

Tiras LED y Neón LED / Tiras LED 12V

M Tira de LED FlexiLight 60 LED/m



GARANTÍA 3 AÑOS



Ref	Lm	Vatios	Acabado	Dimensión	Material	Temperatura de color	PREZZO IVA escl.
LM2361	480 lm/m	4,8 W/m	PCB Blanco	7X5000 mm	PC	6000 K	15,90
LM2362	480 lm/m	4,8 W/m	PCB Blanco	7X5000 mm	PC	4500 K	15,90
LM2363	480 lm/m	4,8 W/m	PCB Blanco	7X5000 mm	PC	3000 K	15,90

conf. scatol.

1 pz	50 pz	Incluye Adhesivo	IP20	50000 H	DC 12V	120°	- 20°C + 45°C	CRI 80	Corte 5 cm
------	-------	------------------	------	---------	--------	------	------------------	--------	------------

Tiras LED y Neón LED / Tiras LED 12V

M Tira de LED Purple 60 LED/m



GARANTÍA 3 AÑOS



Ref	Vatios	Acabado	Dimensión	Material	Temperatura de color	PREZZO IVA escl.
LM2201	14 W/m	PCB Blanco	10X5000 mm	PC	Purple	41,90

conf. scatol.

1 pz	10 pz	Incluye Adhesivo	IP20	30000 H	DC 12V	120°	- 20°C + 45°C	CRI 80	Corte 5 cm
------	-------	------------------	------	---------	--------	------	------------------	--------	------------

Tiras LED y Neón LED / Tiras LED 12V

M Tira de LED

Videny 60 LED/m



GARANTÍA
3 AÑOS

Ref	IP	Lm	Vatios	Acabado	Dimensión	Material	Temperatura de color	PREZZO IVA escl.
LM2001	IP65	1400 lm/m	14 W/m	PCB Blanco	10X5000 mm	PC	6000 K	26,90
LM2409	IP65	1400 lm/m	14 W/m	PCB Blanco	10X5000 mm	PC	2700 K	26,90
LM2002	IP65	1400 lm/m	14 W/m	PCB Blanco	10X5000 mm	PC	4000 K	26,90
LM2005	IP65	1400 lm/m	14 W/m	PCB Blanco	10X5000 mm	PC	3000 K	26,90
LM2010	IP20	1400 lm/m	14 W/m	PCB Blanco	10X5000 mm	PC	6000 K	18,80
LM2016	IP20	1400 lm/m	14 W/m	PCB Blanco	10X5000 mm	PC	4000 K	18,80
LM2014	IP20	1400 lm/m	14 W/m	PCB Blanco	10X5000 mm	PC	3000 K	18,80
LM2410	IP20	1400 lm/m	14 W/m	PCB Blanco	10X5000 mm	PC	2700 K	18,80

conf. scatol.

1 pz	30 pz	Incluye Adhesivo	30000 H	DC 12V	120°	- 20°C + 45°C	CRI 80	Corte 5 cm
------	-------	------------------	---------	--------	------	------------------	--------	------------

Tiras LED y Neón LED / Tiras LED 12V

M Tira de LED Digital Ritt

60 LED/m RGBX



GARANTÍA
3 AÑOS

Ref	Vatios	Onda	Acabado	Dimensión	Material	Temperatura de color	PREZZO IVA escl.
LM2018	14 W/m	R-620-630 G-510-525 B-455-470 nm	PCB Blanco	10X5000 mm	PC	RGBX	67,00



Accesorios



PREZZO IVA escl.
648,00

conf. scatol.

1 pz	30 pz	Incluye Adhesivo	IP20	50000 H	DC 12V	120°	- 20°C + 45°C	CRI 80	Corte 5 cm
------	-------	------------------	------	---------	--------	------	------------------	--------	------------

Tiras LED y Neón LED / Tiras LED 12V

M Tira de LED Digital Messe

60 LED/m RGBX



GARANTÍA
3 AÑOS

Ref	Vatios	Onda	Acabado	Dimensión	Material	Temperatura de color	PREZZO IVA escl.
LM2020	14 W/m	R-620-630 G-510-525 B-455-470 nm	PCB Blanco	10X5000 mm	PC	RGBX	175,00



Accesorios



PREZZO IVA escl.
648,00

conf. scatol.

1 pz	30 pz	Incluye Adhesivo	IP20	50000 H	DC 12V	120°	- 20°C + 45°C	CRI 80	Corte 1 cm
------	-------	------------------	------	---------	--------	------	------------------	--------	------------



Iluminación LED con ritmo

Las tiras digitales LED son una forma eficiente y flexible de iluminación LED que se puede utilizar en una amplia variedad de aplicaciones. Estas tiras utilizan diodos emisores de luz (LED) de alta calidad y están disponibles en diferentes longitudes y densidades de pixel.

En términos simples, las tiras digitales LED están compuestas por una serie de LED conectados en serie y controlados por un microcontrolador programable. Cada LED en la tira puede ser **controlado individualmente** gracias a la tecnología digital, lo que permite crear animaciones y efectos especiales.

Estas tiras son muy versátiles y se pueden utilizar para proporcionar iluminación de acento en interiores, para la iluminación de **talleres, detrás de pantallas de televisión, en festivales, fiestas y eventos, y para crear señalización en edificios y tiendas comerciales.** La posibilidad de programar las tiras digitales LED facilita enormemente el proceso de cambio de colores y efectos de iluminación, lo que las convierte en una opción popular para la decoración y la iluminación personalizadas.

Controlador **DMX RGB** hasta **4096px** compatible con nuestras tiras digitales.

Incluye **4 Canales 256 Niveles (RGB)** y un **transformador con salida 5V DC.**

Con este controlador podremos controlar colores e intensidades de la tira conectada. También incluye un conector **Jack para sonido**, el cuál nos servirá para que nuestra **Tira LED Digital** pueda variar sus colores e intensidades al ritmo de la música.

* Incluye Tarjeta SSD de 128MB, compatible con LEDStudio, podrá visualizar los modos de animación a través del Qr

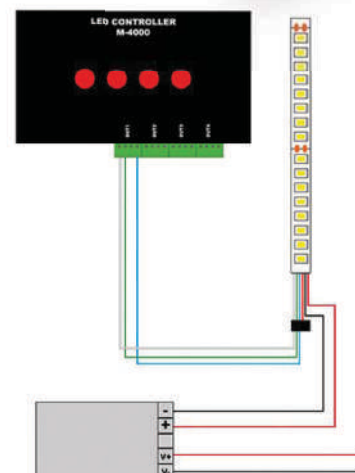

Tiras LED y Neón LED / Tiras LED 24V

M Tira de LED Digital Tips 120 LED/m

INCLUYE
CONTROL
REMOTO

LED
SMD 2835

GARANTÍA
3 AÑOS



Ref	Lm	Vatios	Acabado	Dimensión	Material	Temperatura de color	PREZZO IVAescl.
LM2381	800 lm/m	10 W/m	PCB Blanco	8X5000 mm	PC	6000 K	67,50
LM2382	800 lm/m	10 W/m	PCB Blanco	8X5000 mm	PC	4500 K	67,50
LM2383	800 lm/m	10 W/m	PCB Blanco	8X5000 mm	PC	3000 K	67,50

conf. scatol.

1 pz	50 pz	Incluye Adhesivo	IP20	30000 H	DC 24V	120°	- 20°C + 45°C	CRI 80	Corte 12,5 cm
------	-------	------------------	------	---------	--------	------	------------------	--------	---------------



Iluminación LED animada

Controlador incluido en la tira de LED Tips en monocolor, **dispone de una potencia de 10W/m a 24V DC.**

Desde el controlador tenemos la posibilidad de realizar las siguientes acciones:

- 10 niveles de velocidad
- 10 modos de animación
- función on/off

Podrá visualizar los modos de animación a través del siguiente QR: r:



Tiras LED y Neón LED / Tiras LED 24V

M Tira de LED Serie Clasic

120 LED/m RGB



GARANTÍA
3 AÑOS



Ref	IP	Vatios	Onda	Acabado	Dimensión	Material	Temperatura de color	PREZZO IVAescl.
LM2417	IP20	12 W/m	R-620-630 G-510-525 B-455-470 nm	PCB Blanco	10X5000 mm	PC	RGB	41,90
LM2447	IP65	12 W/m	R-620-630 G-510-525 B-455-470 nm	PCB Blanco	10X5000 mm	PC	RGB	\$2,50



conf. scatol.

1 pz	30 pz	Incluye Adhesivo	30000 H	DC 24V	120°	- 20°C + 45°C	CRI 80	Corte 5 cm
------	-------	------------------	---------	--------	------	------------------	--------	------------

Tiras LED y Neón LED / Tiras LED 24V

M Tira de LED Clasic

120 LED/m RGB



GARANTÍA
3 AÑOS



Ref	Vatios	Onda	Acabado	Dimensión	Material	Temperatura de color	PREZZO IVAescl.
LM2469	12 W/m	R-620-630 G-510-525 B-455-470 nm	PCB Blanco	10X 20000 mm	PC	RGB	239,00



conf. scatol.

1 pz	30 pz	Incluye Adhesivo	IP65	30000 H	DC 24V	120°	- 20°C + 45°C	CRI 80	Corte 4 cm
------	-------	------------------	------	---------	--------	------	------------------	--------	------------

20Mt

Tiras LED y Neón LED / Tiras LED 24V

M Tira de LED Serie Clasic

120 LED/m



GARANTÍA
3 AÑOS



Ref	IP	Lm	Vatios	Acabado	Dimensión	Material	Temperatura de color	PREZZO IVAescl.
LM2411	IP20	1200 lm/m	12 W/m	PCB Blanco	8X5000 mm	PC	6000 K	19,90
LM2412	IP20	1200 lm/m	12 W/m	PCB Blanco	8X5000 mm	PC	4000 K	19,90
LM2413	IP20	1200 lm/m	12 W/m	PCB Blanco	8X5000 mm	PC	2700 K	19,90
LM2414	IP20	1200 lm/m	12 W/m	PCB Blanco	8X5000 mm	PC	Rojo	19,90
LM2415	IP20	1200 lm/m	12 W/m	PCB Blanco	8X5000 mm	PC	Azul	19,90
LM2416	IP20	1200 lm/m	12 W/m	PCB Blanco	8X5000 mm	PC	Verde	19,90
LM2441	IP65	1200 lm/m	12 W/m	PCB Blanco	8X5000 mm	PC	6000 K	29,90
LM2442	IP65	1200 lm/m	12 W/m	PCB Blanco	8X5000 mm	PC	4000 K	29,90
LM2443	IP65	1200 lm/m	12 W/m	PCB Blanco	8X5000 mm	PC	2700 K	29,90
LM2444	IP65	1200 lm/m	12 W/m	PCB Blanco	8X5000 mm	PC	Rojo	29,90
LM2445	IP65	1200 lm/m	12 W/m	PCB Blanco	8X5000 mm	PC	Azul	29,90
LM2446	IP65	1200 lm/m	12 W/m	PCB Blanco	8X5000 mm	PC	Verde	29,90

conf. scatol.

1 pz	30 pz	Incluye Adhesivo	30000 H	DC 24V	120°	- 20°C + 45°C	CRI 80	Corte 5 cm
------	-------	------------------	---------	--------	------	------------------	--------	------------

Tiras LED y Neón LED / Tiras LED 24V

M Tira LED Videny

60 LED/m



GARANTÍA
3 AÑOS



Ref	IP	Vatios	Onda	Acabado	Dimensión	Material	Temperatura de color	PREZZO IVA escl.
LM2226	65	14 W/m	R-620-630 G-510-525 B-455-470 nm	PCB Blanco	10X5000 mm	PC	RGB	31,00
LM2134	20	14 W/m	R-620-630 G-510-525 B-455-470 nm	PCB Blanco	10X5000 mm	PC	RGB	24,90
LM2141	20	14 W/m	R-620-630 G-510-525 B-455-470 nm	PCB Blanco	10X 20000 mm	PC	RGB	194,00



conf. scatola.

1 pz

15 pz

Incluye Adhesivo

30000 H

DC 24V

120°

- 20°C
+ 45°C

CRI 80

Corte 10 cm



Tiras LED y Neón LED / Tiras LED 24V

M Tira de LED Ziadna



GARANTÍA
3 AÑOS



Ref	IP	Lm	LE-D/m	Vatios	Acabado	Corte	Dimensión	Material	Temperatura de color	PREZZO IVA escl.
LM2065	IP20	1600 lm/m	204	18 W/m	PCB Blanco	3 cm	10X5000 mm	PC	6000 K	41,90
LM2066	IP20	1600 lm/m	204	18 W/m	PCB Blanco	3 cm	10X5000 mm	PC	4000 K	41,90
LM2067	IP20	1600 lm/m	204	18 W/m	PCB Blanco	3 cm	10X5000 mm	PC	3000 K	41,90
LM2135	IP20	800 lm/m	120	9 W/m	PCB Blanco	5 cm	8X5000 mm	PC	6000 K	19,90
LM2136	IP20	800 lm/m	120	9 W/m	PCB Blanco	5 cm	8X5000 mm	PC	4000 K	19,90
LM2137	IP20	800 lm/m	120	9 W/m	PCB Blanco	5 cm	8X5000 mm	PC	3000 K	19,90
LM2223	IP65	800 lm/m	120	9 W/m	PCB Blanco	5 cm	8X5000 mm	PC	6000 K	29,00
LM2224	IP65	800 lm/m	120	9 W/m	PCB Blanco	5 cm	8X5000 mm	PC	4000 K	29,00
LM2225	IP65	800 lm/m	120	9 W/m	PCB Blanco	5 cm	8X5000 mm	PC	3000 K	29,00
LM2376	IP20	2000 lm/m	240	20 W/m	PCB Blanco	5 cm	15X5000 mm	PC	6000 K	63,00
LM2377	IP20	2000 lm/m	240	20 W/m	PCB Blanco	5 cm	15X5000 mm	PC	4500 K	63,00
LM2378	IP20	2000 lm/m	240	20 W/m	PCB Blanco	5 cm	15X5000 mm	PC	3000 K	63,00
LM2431	IP20	1900 lm/m	240	19 W/m	PCB Blanco	2,5 cm	10X5000 mm	PC	6000 K	41,00
LM2432	IP20	1900 lm/m	240	19 W/m	PCB Blanco	2,5 cm	10X5000 mm	PC	4000 K	41,00
LM2433	IP20	1900 lm/m	240	19 W/m	PCB Blanco	2,5 cm	10X5000 mm	PC	2700 K	41,00
LM2448	IP65	1900 lm/m	240	19 W/m	PCB Blanco	2,5 cm	8X5000 mm	PC	6000 K	54,00
LM2449	IP65	1900 lm/m	240	19 W/m	PCB Blanco	2,5 cm	8X5000 mm	PC	4000 K	54,00
LM2450	IP65	1900 lm/m	240	19 W/m	PCB Blanco	2,5 cm	8X5000 mm	PC	2700 K	54,00
LM2450	IP65	1900 lm/m	240	19 W/m	PCB Blanco	2,5 cm	8X5000 mm	PC	3000 K	54,00

conf. scatola.

1 pz

30 pz

Incluye Adhesivo

50000 H

DC 24V

120°

- 20°C
+ 45°C

CRI 80

M

Tiras LED y Neón LED / Tiras LED 24V

Tira de LED Videny 60 LED/m

GARANTÍA
3 AÑOS

Ref	Lm	Vatios	Acabado	Dimensión	Material	Temperatura de color	PREZZO IVA escl.
LM2131	1400 lm/m	14 W/m	PCB Blanco	10X5000 mm	PC	6000 K	21,50
LM2132	1400 lm/m	14 W/m	PCB Blanco	10X5000 mm	PC	4000 K	21,50
LM2133	1400 lm/m	14 W/m	PCB Blanco	10X5000 mm	PC	3000 K	21,50

conf. scatola.

1 pz

15 pz

Incluye Adhesivo

IP20

DC 24V

120°

- 20°C
+ 45°C

CRI 80

Corte 10 cm

M

Tiras LED y Neón LED / Tiras LED 24V

Tira de LED Ziadna 120 LED/m

GARANTÍA
3 AÑOS

20Mt

Ref	Lm	Vatios	Acabado	Dimensión	Material	Temperatura de color	PREZZO IVA escl.
LM2421	1200 lm/m	12 W/m	PCB Blanco	10X 20000 mm	PC	6000 K	87,00
LM2422	1200 lm/m	12 W/m	PCB Blanco	10X 20000 mm	PC	4500 K	87,00
LM2423	1200 lm/m	12 W/m	PCB Blanco	10X 20000 mm	PC	2700 K	87,00



conf. scatola.

1 pz

15 pz

Incluye Adhesivo

IP20

30000 H

DC 24V

120°

- 20°C
+ 45°C

CRI 80

Corte 4 cm

M

Tiras LED y Neón LED / Tiras LED 24V

Tira de LED Serie Letters 120 LED/m

GARANTÍA
3 AÑOS

Ref	Lm	Vatios	Acabado	Dimensión	Material	Temperatura de color	PREZZO IVA escl.
LM2461	1400 lm/m	14 W/m	PCB Blanco	8X5000 mm	PC	6000 K	24,70
LM2462	1400 lm/m	14 W/m	PCB Blanco	8X5000 mm	PC	4000 K	24,70
LM2463	1400 lm/m	14 W/m	PCB Blanco	8X5000 mm	PC	2700 K	24,70
LM2464	1400 lm/m	14 W/m	PCB Blanco	8X5000 mm	PC	2300 K	24,70
LM2465	1400 lm/m	14 W/m	PCB Blanco	8X5000 mm	PC	Rojo	24,70
LM2466	1400 lm/m	14 W/m	PCB Blanco	8X5000 mm	PC	Azul	24,70
LM2467	1400 lm/m	14 W/m	PCB Blanco	8X5000 mm	PC	Verde	24,70
LM2468	1400 lm/m	14 W/m	PCB Blanco	8X5000 mm	PC	Rosa	24,70

conf. scatola.

1 pz

20 pz

Incluye Adhesivo

IP20

50000 H

DC 24V

120°

- 20°C
+ 45°C

CRI 80

Corte 8 mm

Tiras LED y Neón LED / Tiras LED 24V

M Tira LED Ziadna 192 LED/m



GARANTÍA
3 AÑOS



Ref	Lm	Vatios	Acabado	Dimensión	Material	Temperatura de color	PREZZO IVA escl.
LM2019	1500 lm/m	14 W/m	PCB Blanco	10X5000 mm	PC	CCT	39,90

Accesorios



conf. scatol.

1 pz	50 pz	Incluye Adhesivo	IP20	50000 H	DC 24V	120°	- 45°C + 60°C	CRI 80	Corte 6 cm
------	-------	------------------	------	---------	--------	------	------------------	--------	------------

Tiras LED y Neón LED / Tiras LED 24V

M Tira de LED Half (5mm de ancho)



GARANTÍA
3 AÑOS



Ref	Lm	Vatios	Acabado	Dimensión	Material	Temperatura de color	PREZZO IVA escl.
LM2214	900 lm/m	9 W/m	PCB Blanco	4X5000 mm	PC	6000 K	22,90
LM2215	900 lm/m	9 W/m	PCB Blanco	4X5000 mm	PC	4000 K	22,90
LM2216	900 lm/m	9 W/m	PCB Blanco	4X5000 mm	PC	3000 K	22,90

conf. scatol.

1 pz	80 pz	Incluye Adhesivo	IP20	50000 H	DC 24V	120°	- 20°C + 45°C	CRI 80	Corte 5 cm
------	-------	------------------	------	---------	--------	------	------------------	--------	------------

Tiras LED y Neón LED / Tiras LED 24V

M Tira de LED CobLED Nake 768 LED/m



GARANTÍA
3 AÑOS



Ref	IP	Vatios	Onda	Acabado	Dimensión	Material	Temperatura de color	PREZZO IVA escl.
LM2471	IP20	15 W/m	R-620-630 G-510-525 B-455-470 nm	PCB Blanco	10X5000 mm	PC	RGB	98,00
LM2472	IP65	15 W/m	R-620-630 G-510-525 B-455-470 nm	PCB Blanco	12X5000 mm	PC	RGB	128,00



conf. scatol.

1 pz	50 pz	Incluye Adhesivo	30000 H	DC 24V	120°	- 20°C + 45°C	CRI 80	Corte 3 cm
------	-------	------------------	---------	--------	------	------------------	--------	------------

Tiras LED y Neón LED / Tiras LED 24V

M Tira de LED CobLED Nake 280 LED/m



GARANTÍA
3 AÑOS



Ref	Lm	Vatios	Acabado	Dimensión	Material	Temperatura de color	PREZZO IVA escl.
LM2231	800 lm/m	10 W/m	PCB Blanco	8X5000 mm	PC	6000 K	44,00
LM2232	800 lm/m	10 W/m	PCB Blanco	8X5000 mm	PC	4500 K	44,00
LM2233	800 lm/m	10 W/m	PCB Blanco	8X5000 mm	PC	3000 K	44,00

conf. scatol.

1 pz	30 pz	Incluye Adhesivo	IP20	50000 H	DC 24V	120°	- 20°C + 45°C	CRI 80	Corte 5 cm
------	-------	------------------	------	---------	--------	------	------------------	--------	------------

Tiras LED y Neón LED / Tiras LED 24V

M Tira LED Videny

96 LED/m



GARANTÍA
3 AÑOS



Ref	IP	Vatios	Onda	Acabado	Dimensión	Material	Temperatura de color	PREZCO IVA escl.
LM2379	IP20	12 W/m	R-620-630 G-510-525 B-455-470 nm	PCB Blanco	10X5000 mm	PC	RGB	40,90
LM2380	IP65	12 W/m	R-620-630 G-510-525 B-455-470 nm	PCB Blanco	10X5000 mm	PC	RGB	47,90

conf. scacol.

1 pz	30 pz	Incluye Adhesivo	30000 H	DC 24V	120°	-20°C +45°C	CRI 80	Corte 6 cm
------	-------	------------------	---------	--------	------	----------------	--------	------------

Tecnología LED

¿Qué es chip LED?

El chip LED es una pieza rectangular compuesta por capas de diversos materiales semiconductores que son capaces de convertir la electricidad en luz.

¿Cuál es la tira de LED que más ilumina?

Las tiras de LED tipo 5050 son de alta potencia y mayor consumo. Por norma, este tipo de tiras se usan para iluminación de ambientes, cartelería, etc. y su consumo ronda los **14w el metro** en su versión de **60 LED/m**, ofreciendo **3 veces** más lúmenes que la tira **3528**.

¿Cuánto tiempo de vida tiene un LED?

Las bombillas de bajo consumo rompieron la baraja al superar las **15.000 horas** de vida útil. Y entonces llegó la tecnología LED, con bombillas que duran aproximadamente **50.000 horas**. Esto equivale a tenerlas encendidas **5 años sin interrupción**.

Tipos de LED

Podemos distinguir entre cuatro tipos básicos de LED:

- LED DIP o Dual In-Line Package
- LED SMD o Surface Mounted Diode
- LED COB o Chip on Board
- MicroLED

A continuación describiremos con más detalle cada uno de ellos.

Chip LED DIP

Los DIP (Dual In-Line Package) LED son las luces LED tradicionales y en las que piensa la mayoría de la gente cuando se les pide que describan un LED. Su diseño consta de un diodo dentro de una carcasa de plástico duro transparente, del que sobresalen dos pines de conexión en paralelo. Del color de esta carcasa dependerá la luz que emite el LED.

A pesar de que hoy en día se siguen utilizando los chips DIP, su baja eficiencia lumínica (4 Lúmenes por LED) respecto a los LED más recientes, hace que su uso sea más extendido en como indicador luminoso en diferentes productos electrónicos.

Chip LED SMD

Las siglas SMD significan " **Surface Mounted**

Diode", y en esta opción el diodo está encapsulado en una resina semi-rígida que se suelda al circuito de forma superficial. Son mucho más pequeños y eficientes que los originales chips DIP.

El desarrollo de los chips SMD supuso un gran avance en la tecnología LED, al permitir la inclusión de 3 diodos en el mismo chip. Recordemos que hasta ahora una de las formas de conseguir luz blanca es la unión de los 3 colores primarios, Rojo, Verde y Azul, de ahí la importancia de este avance. Con esta combinación se consiguen también hasta 16 millones de colores diferentes.

La otra opción para conseguir luz blanca es es recubrir el chip con una capa de fósforo que absorbe la luz azul, de ahí ese color amarillo característico. La densidad de esta capa determina la temperatura de color del chip SMD.

Tiras LED SMD 2835

Con un tamaño de **2,8mm x 3,5mm**, este tipo de tiras cuenta con un chip más pequeño. Son chips de un sólo núcleo y por ende, capaces de reproducir solamente **1 color por LED (blanco, azul, rojo, amarillo, verde)**.

Se trata de la tira de menor consumo y más económica con respecto al precio, por lo que es la mejor opción para proyectos de bajo presupuesto o sin grandes requerimientos lumínicos.

Pueden resultar una estupenda opción para resaltar muebles, zócalos, exhibidores, aparatos y detalles arquitectónicos.

Las desventajas que poseen es la luminosidad reducida en comparación a las tiras de otros chips, y que sus chips de un sólo núcleo no permiten emitir más de un color por LED (no sirven para iluminación RGB).

Tiras LED SMD 5050

Este tipo de tiras poseen un chip de mayor tamaño, de **5mm x 5mm**, que les otorga su denominación. Sus chips son **multinúcleo**, lo que le permite generar a cada LED **cualquier tonalidad de color**, ya que en el interior alberga **3 emisores de luz diferentes (rojo, verde y azul)**. Gracias a esto, una tira **SMD 5050** puede generar **miles de**

combinaciones de colores diferentes, y son la utilizadas para iluminación **RGB** personalizable (mediante un controlador manejado por el propio usuario).

Son bastante más potentes que los chips de menor tamaño, por lo que brindan una mayor emisión de luz (**hasta 3 veces mayor**). Gracias a su elevada potencia, son apropiadas para la utilización en exteriores, o en lugares expuestos a mayores niveles de luz ambiental.

Como desventajas respecto a las anteriores están por supuesto el precio, que es algo más elevado, como así también el consumo y la generación de calor.

Tiras LED SMD 3535

Los LEDs 3535 son un tipo de diodo emisor de luz de alta potencia, diseñado para producir una iluminación potente y uniforme en aplicaciones de iluminación de exteriores e interiores.

Estos LEDs tienen una estructura cuadrada de **3,5 mm x 3,5 mm** y pueden producir hasta 3 watts de luz.

Además, los LEDs 3535 son famosos por su **Alta eficiencia luminosa** y la capacidad de brindar una amplia gama de opciones de color y temperatura de color.

También son muy duraderos y pueden durar hasta **50.000 horas** de uso continuo, lo que los convierte en una excelente opción para la iluminación de grandes espacios, como estacionamientos, áreas deportivas y fachadas de edificios.



Tiras LED y Neón LED / Tiras LED 12V

M Pack Tira de LED Solar 300L

INCLUYE CONTROL REMOTO



GARANTÍA 3 AÑOS



Ref	Lm	Vatios	Acabado	Dimensión	Material	Temperatura de color	PREZZO IVA esd.
LM2424	600	4	PCB Blanco	10X5000 mm	PC	CCT	



Incluye Adhesivo	IP68	30000 H	120°	- 20°C + 45°C	CRI 70	Sensor crepuscular	Batería 3.7V 2400mAH	Carga 10-12 Hr	Uso 10-12 Hr
------------------	------	---------	------	------------------	--------	--------------------	----------------------	----------------	--------------

Tiras LED y Neón LED / Tiras LED 12V

M Pack Tira de LED Solar 300L

INCLUYE CONTROL REMOTO



GARANTÍA 3 AÑOS



Ref	Onda	Vatios	Acabado	Dimensión	Material	Temperatura de color	PREZZO IVA esd.
LM2425	R-620-630 G-510-525 B-455-470 nm	4	PCB Blanco	10X5000 mm	PC	Multicolor	



Incluye Adhesivo	IP68	30000 H	120°	- 20°C + 45°C	CRI 70	Sensor crepuscular	Batería 3.7V 2400mAH	Carga 10-12 Hr	Uso 10-12 Hr
------------------	------	---------	------	------------------	--------	--------------------	----------------------	----------------	--------------



Tiempo de carga
10-12 Hr



Tiempo de uso
10-12 Hr



Sensor
Crepuscular



Protección
IP68



Vida útil
30.000 Hr



Tiras LED y Neón LED / Tiras LED 12V

M Pack Tira de LED 12V 60 LED/m CCT

INCLUYE CONTROL REMOTO

LED
SMD 3535

GARANTÍA 3 AÑOS



Ref	Lm	Vatios	Acabado	Dimensión	Material	Temperatura de color	PREZZO IVA escl.
LM2401	1760	22	PCB Blanco	10X3000 mm	PC	CCT	20,90
LM2403	2400	30	PCB Blanco	10X5000 mm	PC	CCT	23,90

conf. scatol.

1 pz	20 pz	Incluye Adhesivo	IP20	30000 H	DC 12V	120°	- 20°C + 45°C	CRI 80	Corte 10 cm
------	-------	------------------	------	---------	--------	------	------------------	--------	-------------

Tiras LED y Neón LED / Tiras LED 12V

M Pack Tira de LED 12V 30 LED/m RGB

INCLUYE CONTROL REMOTO

LED
SMD5050

GARANTÍA 3 AÑOS



Ref	Onda	Vatios	Acabado	Dimensión	Material	Temperatura de color	PREZZO IVA escl.
LM2402	R-620-630 G-510-525 B-455-470 nm	16	PCB Blanco	10X3000 mm	PC	RGB	21,90
LM2404	R-620-630 G-510-525 B-455-470 nm	24	PCB Blanco	10X5000 mm	PC	RGB	26,90



conf. scatol.

1 pz	20 pz	Incluye Adhesivo	IP20	30000 H	DC 12V	120°	- 20°C + 45°C	CRI 80	Corte 10 cm
------	-------	------------------	------	---------	--------	------	------------------	--------	-------------

WORLD OF COLORS



Tiras LED y Neón LED / Tiras LED 24V

M Pack Tira de LED 24V 16 LED/m

INCLUYE CONTROL REMOTO



GARANTÍA 3 AÑOS



Ref	Onda	Vatios	Acabado	Dimensión	Material	Temperatura de color	PREZZO IVA escl.
LM2405	R-620-630 G-510-525 B-455-470 nm	26	PCB Blanco	10X30000 mm	PC	RGB	44,90
LM2406	R-620-630 G-510-525 B-455-470 nm	13	PCB Blanco	10X15000 mm	PC	RGB	31,90



conf. scatola.

1 pz

40 pz

Incluye Adhesivo

IP20

30000 H

DC 24V

120°

- 20°C
+ 45°C

CRI 80

Corte 50 cm



Multicolored LED Lighting

Tiras LED y Neón LED / Tiras LED 220V

M Barra LED Para Estanterías



GARANTÍA
3 AÑOS

Ref	Lm	Vatios	Acabado	Dimensión	Material	Temperatura de color	PREZZO IVA escl.
LM6237	980	12	Transparente	1100X35X10 mm	Metal/PC	6000 K	5,95

conf. scatol.

1 pz	10 pz	NO Incluye Adhesivo	IP20	30000 H	120°	CRI 70	Enlazable Max 10 m
------	-------	---------------------	------	---------	------	--------	--------------------



Alumbrando hasta el último rincón

Barra LED para Estanterías 12W IP20, de diseño sencillo y de fácil instalación.

Permite enlazar una con otra con un límite de **10 unidades** a través de un accesorio incluido en el producto.

Incorpora **SMD-LED 2835** de alta potencia y eficiencia lumínica.

Su sencillo diseño minimalista junto con su reducido tamaño, lo hacen ideal para iluminar espacios como estanterías.

Las barras LED para estanterías son tiras de diodos emisores de luz (LED) especialmente diseñadas para proporcionar iluminación en estanterías y armarios. Estas barras LED suelen tener un diseño delgado y una longitud personalizable que facilita su instalación en estantes y armarios.

La iluminación proporcionada por las barras LED para estanterías es suave y uniforme, lo que permite a los usuarios ver claramente los objetos almacenados en los estantes y los armarios, sin causar deslumbramiento. Además, el bajo consumo de energía de los LED, significa que las barras LED para estanterías consumen menos energía que las bombillas tradicionales, y son más duraderas ya que pueden durar hasta **50,000 horas**, lo que las convierte en una excelente opción para la iluminación en la casa, la oficina o cualquier lugar donde se necesite una mayor visibilidad en estantes o armarios.

Tiras LED y Neón LED / Tiras LED 220V

M Tira de LED Ruzok 220V 120 LED/m



GARANTÍA 5 AÑOS

20Mt



Ref	Lm	Vatios	Acabado	Dimensión	Material	Temperatura de color	PREZZO IVA escl.
LM2163	1680 lm/m	17 W/m	Transparente	12X5H mm	Silicona Contra Rayos UV	6000 K	303,00
LM2164	1680 lm/m	17 W/m	Transparente	12X5H mm	Silicona Contra Rayos UV	4500 K	303,00
LM2165	1680 lm/m	17 W/m	Transparente	12X5H mm	Silicona Contra Rayos UV	3000 K	303,00

Accesorios



Cable LM2038
Cable LM0004
Adaptador LM2359
Cable LM0001
Tapón LM0005

conf. scatol.

1 pz	5 pz	Incluye Adhesivo	IP67	50000 H	AC 170 265V	120°	CRI 90	F.P 0.90	Corte 10 cm	Enlazable Max 20 m
------	------	------------------	------	---------	-------------	------	--------	----------	-------------	--------------------

Tiras LED y Neón LED / Tiras LED 220V

M Tira de LED Brescia 220V 110 LED/m



GARANTÍA 3 AÑOS

20Mt



Ref	Lm	Vatios	Acabado	Dimensión	Material	Temperatura de color	PREZZO IVA escl.
LM2341	1560 lm/m	12 W/m	Transparente	12X5H mm	Silicona Contra Rayos UV	6000 K	186,00
LM2342	1560 lm/m	12 W/m	Transparente	12X5H mm	Silicona Contra Rayos UV	4500 K	186,00
LM2343	1560 lm/m	12 W/m	Transparente	12X5H mm	Silicona Contra Rayos UV	3000 K	186,00
LM2344	1560 lm/m	12 W/m	Transparente	12X5H mm	Silicona Contra Rayos UV	2300 K	186,00

Accesorios



Cable LM2038
Cable LM0004
Adaptador LM2359
Cable LM0001
Tapón LM0005

Incluye Adhesivo	IP67	50000 H	AC 170 265V	120°	CRI 90	F.P 0.90	Corte 10 cm	Enlazable Max 20 m
------------------	------	---------	-------------	------	--------	----------	-------------	--------------------

conf. scatol.

1 pz	5 pz
------	------

ALL TERRAIN

IP67 / High quality silicone / Self-adhesive / Without rectifier

Tiras LED y Neón LED / Tiras LED 220V

M Tira de LED Cobpro 220V



GARANTÍA 3 AÑOS



SIN RECTIFICADOR



20Mt

Ref	Lm	Vatios	Acabado	Dimensión	Material	Temperatura de color	PREZZO IVA escl.
LM2336	2200 lm/m	20 W/m	Transparente	10X5H mm	Silicona Contra Rayos UV	6000 K	330,00
LM2337	2200 lm/m	20 W/m	Transparente	10X5H mm	Silicona Contra Rayos UV	4000 K	330,00
LM2338	2200 lm/m	20 W/m	Transparente	10X5H mm	Silicona Contra Rayos UV	2700 K	330,00
LM2339	2200 lm/m	20 W/m	Transparente	10X5H mm	Silicona Contra Rayos UV	2300 K	330,00

Accesorios



conf. scatol.

1 pz	5 pz	Incluye Adhesivo	IP65	30000 H	AC 170 265V	120°	CRI 80	F.P 0.90	Corte 16,6 cm	Enlazable Max 20 m
------	------	------------------	------	---------	-------------	------	--------	----------	---------------	--------------------

Tiras LED y Neón LED / Tiras LED 220V

M Tira de LED RGB Fast 60 LED/m



GARANTÍA 3 AÑOS



Ref	Vatios	Onda	Acabado	Dimensión	Material	Temperatura de color	PREZZO IVA escl.
LM2309	14 W/m	R-620-630 G-510-525 B-455-470 nm	Transparente	15X6 mm	Silicona / PC / Epoxy	RGB	298,90

Accesorios



conf.

1 pz	NO Incluye Adhesivo	IP65	30000 H	AC 170 265V	120°	- 20°C + 45°C	CRI 80	Corte 1 m	Enlazable Max 20 m
------	---------------------	------	---------	-------------	------	---------------	--------	-----------	--------------------

Tiras LED y Neón LED / Tiras LED 220V

M Tira de LED Fast 120 LED/m



GARANTÍA 3 AÑOS



Ref	Vatios	Lm	Acabado	Dimensión	Material	Temperatura de color	PREZZO IVA escl.
LM2301	14 W/m	1440 lm/m	Transparente	15X6 mm	Silicona / PC / Epoxy	6000K	222,90
LM2302	14 W/m	1440 lm/m	Transparente	15X6 mm	Silicona / PC / Epoxy	4500K	233,90
LM2303	14 W/m	1440 lm/m	Transparente	15X6 mm	Silicona / PC / Epoxy	3000K	233,90
LM2304	14 W/m	1440 lm/m	Transparente	15X6 mm	Silicona / PC / Epoxy	2300K	233,90
LM2305	14 W/m	1440 lm/m	Transparente	15X6 mm	Silicona / PC / Epoxy	Rojo	233,90
LM2306	14 W/m	1440 lm/m	Transparente	15X6 mm	Silicona / PC / Epoxy	Azul	233,90
LM2307	14 W/m	1440 lm/m	Transparente	15X6 mm	Silicona / PC / Epoxy	Rosa	233,90
LM2308	14 W/m	1440 lm/m	Transparente	15X6 mm	Silicona / PC / Epoxy	Verde	233,90

Accesorios



conf.

1 pz	50 mt	NO Incluye Adhesivo	IP65	30000 H	AC 170 265V	120°	- 20°C + 45°C	CRI 80	Corte 50 cm	Enlazable Max 20 m
------	-------	---------------------	------	---------	-------------	------	---------------	--------	-------------	--------------------

Tiras LED y Neón LED / Tiras LED 220V

M Tira de LED Bergamo



GARANTÍA 3 AÑOS



SIN RECTIFICADOR



Ref	LE-D/m	Lm	Vatios	Acabado	Dimensión	Material	Temperatura de color	PREZZO IVAescl.
LM2331	120	1500 lm/m	17 W/m	Transparente	10X3H mm	Silicona Contra Rayos UV	6000 K	570,00
LM2332	120	1500 lm/m	17 W/m	Transparente	10X3H mm	Silicona Contra Rayos UV	4000 K	570,00
LM2333	120	1500 lm/m	17 W/m	Transparente	10X3H mm	Silicona Contra Rayos UV	2700 K	570,00
LM2345	110	1000 lm/m	12 W/m	Transparente	10X3H mm	Silicona Contra Rayos UV	6000 K	526,00
LM2346	110	1000 lm/m	12 W/m	Transparente	12X3H mm	Silicona Contra Rayos UV	4000 K	526,00
LM2347	110	1000 lm/m	12 W/m	Transparente	12X3H mm	Silicona Contra Rayos UV	3000 K	526,00
LM2348	110	1000 lm/m	12 W/m	Transparente	12X3H mm	Silicona Contra Rayos UV	2300 K	526,00
LM2349	110	1000 lm/m	12 W/m	Transparente	12X3H mm	Silicona Contra Rayos UV	2700 K	526,00

Accesorios



Cable LM2358 2,35 10pz 100pz

conf. scatol.

1 pz	1 pz	Incluye Adhesivo	IP65	50000 H	AC 170 265V	120°	CRI 80	F.P 0,90	Corte 10 cm	Enlazable Max 50 m
------	------	------------------	------	---------	-------------	------	--------	----------	-------------	--------------------

Tiras LED y Neón LED / Tiras LED 220V

M Tira de LED Como 220V 110 LED/m



GARANTÍA 3 AÑOS



SIN RECTIFICADOR



Ref	Lm	Vatios	Acabado	Dimensión	Material	Temperatura de color	PREZZO IVAescl.
LM2351	1400 lm/m	12 W/m	Transparente	14X6 mm	Silicona / PC / Epoxy	6000 K	290,00
LM2352	1400 lm/m	12 W/m	Transparente	14X6 mm	Silicona / PC / Epoxy	4000 K	290,00
LM2353	1400 lm/m	12 W/m	Transparente	14X6 mm	Silicona / PC / Epoxy	3000 K	290,00
LM2354	1400 lm/m	12 W/m	Transparente	14X6 mm	Silicona / PC / Epoxy	2300 K	290,00

Accesorios



Cable LM2357 5,90 10pz 100pz

conf.

1 pz	NO Incluye Adhesivo	IP65	30000 H	AC 170 265V	120°	CRI 80	Corte 10 cm	Enlazable Max 50 m
------	---------------------	------	---------	-------------	------	--------	-------------	--------------------

Tiras LED y Neón LED / Tiras LED 220V

M Tira de LED Arast 220V 180 LED/m



GARANTÍA 3 AÑOS



SIN RECTIFICADOR



Ref	Lm	Vatios	Acabado	Dimensión	Material	Temperatura de color	PREZZO IVAescl.
LM2314	1584 lm/m	14 W/m	Opal	17X8 mm	Silicona / PC / Epoxy	6000 K	342,00
LM2315	1584 lm/m	14 W/m	Opal	17X8 mm	Silicona / PC / Epoxy	4500 K	342,00

Accesorios



Rectificador LM2313 4,50 1pz 10pz

conf.

1 pz	NO Incluye Adhesivo	IP65	30000 H	AC 220 240V	120°	CRI 80	Corte 1 m	Enlazable Max 20 m
------	---------------------	------	---------	-------------	------	--------	-----------	--------------------

Tiras LED y Neón LED / Neón LED 220V

M Neón de LED Flexible Prozny 220V



GARANTÍA 3 AÑOS



Ref	Lm	Vatios	Acabado	Dimensión	Material	Temperatura de color	PREZZO IVAescl.
LM2157	800 lm/m	8 W/m	Opal	26X14 mm	Silicona / PC / Epoxy	RGB	724,00



Accesorios



Controlador LM2161 28,90 1 pz 10 pz
Controlador LM2160 8,90 1 pz 10 pz

conf. scatol.

1 pz	1 pz	NO Incluye Adhesivo	IP65	30000 H	AC 170 265V	180°	CRI 80	Corte 1 m	Enlazable Max 20 m
------	------	---------------------	------	---------	-------------	------	--------	-----------	--------------------

Tiras LED y Neón LED / Neón LED 220V

M Neón de LED Flexible Prozny 220V



GARANTÍA 3 AÑOS



Ref	Lm	Vatios	Acabado	Dimensión	Material	Temperatura de color	PREZZO IVAescl.
LM2150	800 lm/m	8 W/m	Opal	18X8 mm	Silicona / PC / Epoxy	3000K	472,00
LM2151	800 lm/m	8 W/m	Opal	18X8 mm	Silicona / PC / Epoxy	4500K	472,00
LM2152	800 lm/m	8 W/m	Opal	18X8 mm	Silicona / PC / Epoxy	6000K	472,00
LM2153	800 lm/m	8 W/m	Opal	18X8 mm	Silicona / PC / Epoxy	Azul	472,00
LM2154	800 lm/m	8 W/m	Opal	18X8 mm	Silicona / PC / Epoxy	Rojo	472,00
LM2155	800 lm/m	8,5 W/m	Opal	18X8 mm	Silicona / PC / Epoxy	Verde	472,00

Accesorios



Controlador LM2158 45,90

conf. scat.

1 pz	50 pz	NO Incluye Adhesivo	IP65	30000 H	AC 170 265V	180°	CRI 80	Corte 1 m	Enlazable Max 20 m
------	-------	---------------------	------	---------	-------------	------	--------	-----------	--------------------

Tiras LED y Neón LED / Tiras LED 220V

Tira de LED Mixt 220V



GARANTÍA 3 AÑOS



Ref	Lm	Vatios	Acabado	Dimensión	Material	Temperatura de color	PREZZO IVAescl.
LM2239	1584 lm/m	14 W/m	Opal	16X8 mm	Silicona / PC / Epoxy	CCT	264,90

Accesorios



Controlador LM2039

conf. scat.

1 pz	1 pz	NO Incluye Adhesivo	IP65	30000 H	AC 220 240V	120°	CRI 80	F.P 0.90	Corte 1 m	Enlazable Max 20 m
------	------	---------------------	------	---------	-------------	------	--------	----------	-----------	--------------------

Tiras LED y Neón LED / Neón LED 12V

M Neón de LED Flexible Letters



GARANTÍA 3 AÑOS



SIN RECTIFICADOR



Ref	Lm	Vatios	Acabado	Dimensión	Material	Temperatura de color	PREZZO IVA escl.
LM2481	1200 lm/m	14 W/m	Opal	5000X6X12H mm	PC	6000 K	346,00
LM2482	1200 lm/m	14 W/m	Opal	5000X6X12H mm	PC	4000 K	346,00
LM2483	1200 lm/m	14 W/m	Opal	5000X6X12H mm	PC	2700 K	346,00
LM2484	1200 lm/m	14 W/m	Opal	5000X6X12H mm	PC	Rojo	402,00
LM2485	1200 lm/m	14 W/m	Opal	5000X6X12H mm	PC	Verde	346,00
LM2486	1200 lm/m	14 W/m	Opal	5000X6X12H mm	PC	Azul	346,00
LM2487	1200 lm/m	14 W/m	Opal	5000X6X12H mm	PC	Violeta	346,00
LM2488	1200 lm/m	14 W/m	Opal	5000X6X12H mm	PC	Rosa	346,00
LM2489	1200 lm/m	14 W/m	Opal	5000X6X12H mm	PC	Dorado	346,00
LM2490	1200 lm/m	14 W/m	Opal	5000X6X12H mm	PC	Naranja	346,00

Accesorios

Tapón e inicio
LM0042 2,15 10 pz 100 pz

conf. scat.

1 pz	10 pz	NO Incluye Adhesivo	IP65	30000 H	DC 12V	180°	- 20°C + 45°C	CRI 80	Corte 1 cm
------	-------	---------------------	------	---------	--------	------	------------------	--------	------------



ILLUMINATE YOUR IDEAS

Imagine a world of color



Tiras LED y Neón LED / Fuentes de Alimentación Interior

Fuentes de Alimentación Mean Well Para tiras LED



GARANTÍA
3 AÑOS



Ref	Voltaje	Pot max	Dimensión	Material	PREZZO IVA escl.
LRS-35-12	12V	35W	99X82X30H mm	Aluminio	31,60
LRS-75-12	12V	75 W	99X97X30H mm	Aluminio	43,90
LRS-100-12	12V	100 W	129X97X30H mm	Aluminio	36,90
LRS-150-12	12V	150 W	159X97X30H mm	Aluminio	46,80
LRS-200-12	12V	200 W	215X115X30H mm	Aluminio	56,80
LRS-350-12	12V	350 W	215X115X30H mm	Aluminio	80,90
LRS-15-24	24V	15 W	62,5X51X28H mm	Aluminio	23,90
LRS-35-24	24V	35 W	99X82X30H mm	Aluminio	31,50
LRS-75-24	24V	75 W	99X97X30H mm	Aluminio	35,80
LRS-100-24	24V	100 W	129X97X30H mm	Aluminio	37,90
LRS-150-24	24V	150 W	159X97X30H mm	Aluminio	44,00
LRS-200-24	24V	200 W	215X115X30H mm	Aluminio	59,50
LRS-350-24	24V	350 W	215X115X30H mm	Aluminio	73,50

1 pz

conf.

15 pz

scat.

IP20

AC 170
265V

-30°C
+70°C

F.P
>0.50



Tiras LED y Neón LED / Fuentes de Alimentación Interior 12V

Fuentes de Alimentación Para tiras LED

GARANTÍA
3 AÑOS



Ref	Acabado	Dimensión	Material	PREZZO IVA escl.
LM2042	Metal	70X40X30 mm	Aluminio	7,10
LM2043	Metal	85X58X34 mm	Aluminio	11,50

conf.

scat.

1 pz

80 pz

IP20

AC 110
240V

- 30°C
+ 60°C

F.P
>0.50

Salida
DC 12V



Tiras LED y Neón LED / Fuentes de Alimentación Interior

Fuentes de Alimentación Slim Para tiras LED

GARANTÍA
3 AÑOS



Ref	Voltaje	Pot max	Dimensión	Material	PREZZO IVA escl.
LM2244	12V	60 W	144X53X21H mm	Aluminio	15,50
LM2245	12V	100 W	168X53X21H mm	Aluminio	22,90
LM2246	12V	200 W	306X53X20H mm	Aluminio	32,90
LM2247	12V	300 W	307X52X22H mm	Aluminio	36,99
LM2248	12V	400 W	340X52X22H mm	Aluminio	48,80
LM2251	24V	60 W	144X53X21H mm	Aluminio	16,90
LM2252	24V	100 W	168X53X21H mm	Aluminio	22,30
LM2253	24V	200 W	306X53X20H mm	Aluminio	33,90
LM2254	24V	300 W	307X52X22H mm	Aluminio	37,30
LM2255	24V	400 W	340X52X22H mm	Aluminio	49,70

conf.

scat.

1 pz

60 pz

IP25

AC 220
240V

-20 °C
+60 °C

F.P
>0.50

Tiras LED y Neón LED / Fuentes de Alimentación Interior 24V

M Fuentes de Alimentación Dimable por Triac

GARANTÍA
3 AÑOS



Ref	Pot max	Acabado	Dimensión	Material	PREZZO IVA escl
LM2106	80 W	Negro	230X49X29H mm	Aluminio	71,00
LM2107	150 W	Negro	288X49X29H mm	Aluminio	128,00

conf.	scat.	IP20	AC 200 240V	F.P 0.90	Salida DC 24V
1 pz	50 pz				

Triac

La regulación por triac se refiere a la técnica de controlar la cantidad de corriente que circula a través de un circuito eléctrico utilizando un dispositivo conocido como triac.

El triac es un componente semiconductor que se utiliza en aplicaciones de control de potencia de **CA**, y permite el control de la cantidad de corriente que fluye a través de un circuito eléctrico al variar el instante en que se dispara el triac.

De esta manera, se puede regular la cantidad de energía que se entrega a un dispositivo eléctrico, lo que puede ser útil en muchas aplicaciones de control de potencia, como el control de la velocidad de un motor eléctrico o la regulación del brillo de una lámpara.

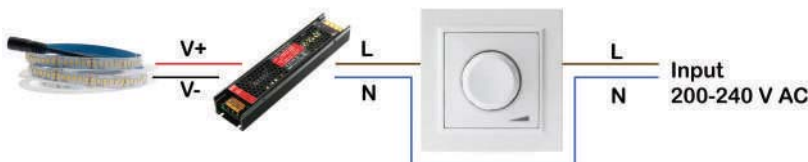

Tiras LED y Neón LED / Fuentes de Alimentación Interior

M Fuentes de Alimentación Dimable 0-10V

GARANTÍA
3 AÑOS



Ref	Voltaje	Pot max	Acabado	Dimensión	Material	PREZZO IVAescl.
LM2521	12V	60W	Negro	190X50X29H mm	Aluminio	48,90
LM2522	12V	100W	Negro	230X50X29H mm	Aluminio	48,90
LM2523	12V	150W	Negro	300X48X29H mm	Aluminio	64,90
LM2524	12V	200W	Negro	300X48X29H mm	Aluminio	86,60
LM2525	24V	60W	Negro	190X50X29H mm	Aluminio	48,50
LM2526	24V	100W	Negro	230X50X29H mm	Aluminio	56,80
LM2527	24V	150W	Negro	300X48X29H mm	Aluminio	70,60
LM2528	24V	200W	Negro	300X48X29H mm	Aluminio	94,90

conf. scat.

1 pz

1 pz

IP20

AC 200
240V

- 20°C
+ 65°C

F.P
0.80

1-10V

La regulación **1-10V** es un estándar de control de iluminación que utiliza una señal de corriente continua de 1 a 10 voltios para controlar el nivel de intensidad de la luz.

Esta tecnología es comúnmente usada en sistemas de iluminación **LED** y permite ajustar la intensidad de la luz de forma **fácil y suave**.

Los controles **1-10V** son fáciles de instalar y permiten un control preciso de la iluminación en la mayoría de los entornos.

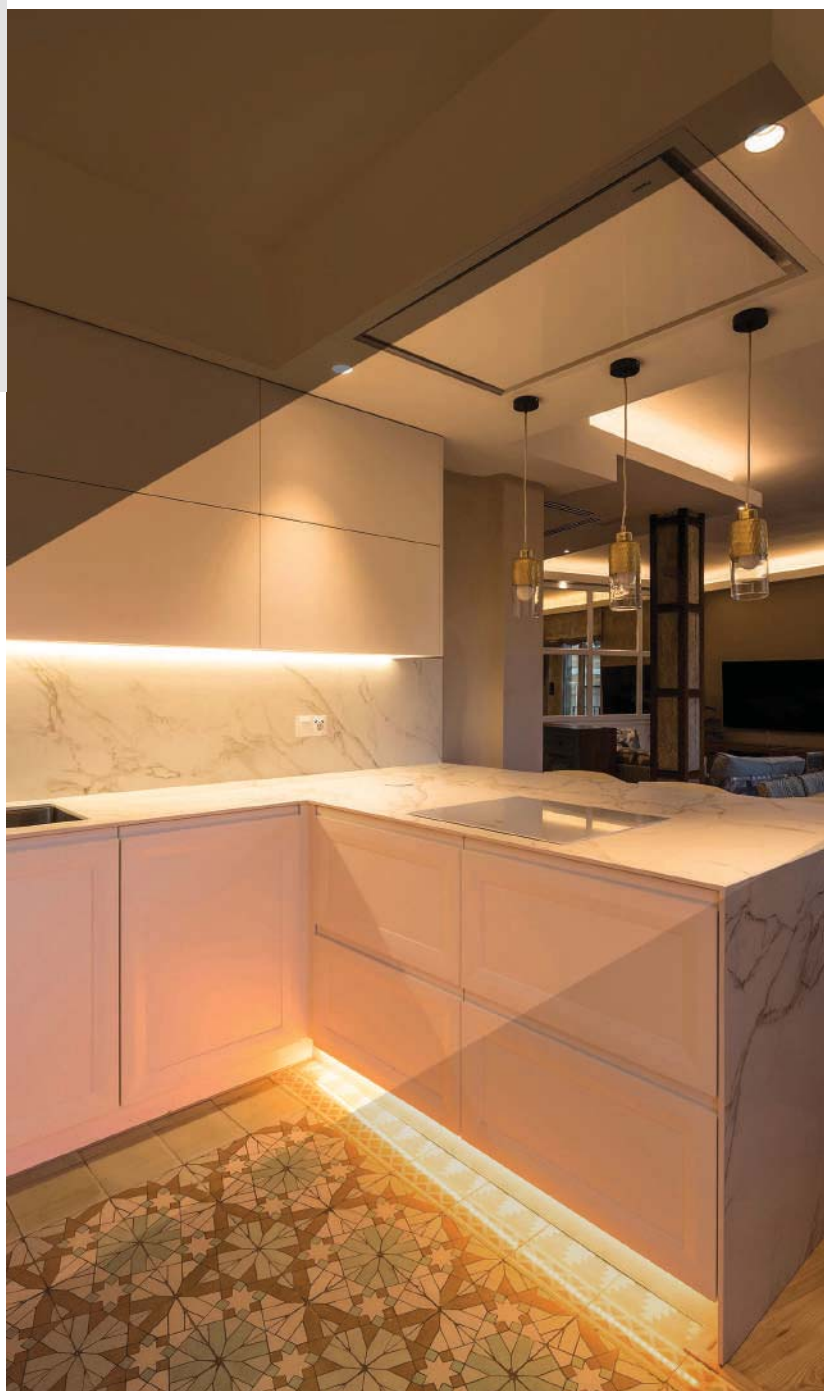
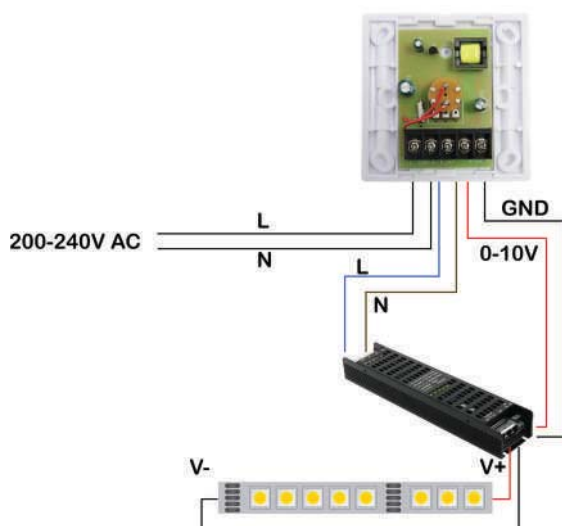

Tiras LED y Neón LED / Fuentes de Alimentación Interior

M Fuente de Alimentación Para tiras LED (Especial para perfiles)

GARANTÍA 3 AÑOS



Ref	Voltaje	Pot max	Dimensión	Material	PREZZO IVA escl.
LM2242	12V	15 W	172X18X18H mm	Aluminio	7,10
LM2258	12V	60 W	290X13X13H mm	Aluminio	11,90
LM2260	24V	72 W	290X13X13H mm	Aluminio	14,40

conf.	scat.	IP20	AC 180 260V	F.P 0.50
1 pz	1 pz			

Tiras LED y Neón LED / Fuentes de Alimentación Exterior

M Fuentes de Alimentación Para tiras LED

GARANTÍA 3 AÑOS



Ref	Voltaje	Pot max	Dimensión	Material	PREZZO IVA escl.
LM2529	12V	60 W	162X43X31H mm	PC	32,90
LM2530	12V	100 W	190X62X38H mm	PC	46,50
LM2531	12V	150 W	190X62X38H mm	PC	57,60
LM2532	24V	60 W	162X43X31H mm	PC	32,80
LM2533	24V	100 W	190X62X38H mm	PC	47,20
LM2534	24V	150 W	190X62X38H mm	PC	57,90

conf.	scat.	IP66	AC 170 265V	-40°C +50°C	F.P 0.55
1 pz	1 pz				

Tiras LED y Neón LED / Fuentes de Alimentación Exterior

M Fuentes de Alimentación Para Tiras LED

GARANTÍA 3 AÑOS



Ref	Voltaje	Pot max	Acabado	Dimensión	Material	PREZZO IVA escl.
LM2501	12V	36 W	Aluminio	102X36X21H mm	Aluminio	13,50
LM2504	12V	120 W	Aluminio	167X53X20H mm	Aluminio	37,70
LM2506	12V	200 W	Aluminio	193X65X29H mm	Aluminio	54,90
LM2507	12V	250 W	Aluminio	193X65X29H mm	Aluminio	58,90
LM2508	12V	300 W	Aluminio	203X70X42H mm	Aluminio	69,00
LM2509	12V	400 W	Aluminio	223X70X40H mm	Aluminio	89,90
LM2510	24V	36 W	Aluminio	102X36X21H mm	Aluminio	13,50
LM2513	24V	120 W	Aluminio	167X53X20H mm	Aluminio	37,70
LM2515	24V	200 W	Aluminio	193X65X29H mm	Aluminio	54,90
LM2516	24V	250 W	Aluminio	193X65X29H mm	Aluminio	58,90
LM2517	24V	300 W	Aluminio	203X70X42H mm	Aluminio	69,00
LM2518	24V	400 W	Aluminio	223X70X40H mm	Aluminio	89,90

conf.	scat.	IP65	AC 200 240V	-20°C +60°C	F.P 0.80
1 pz	1 pz				

Tiras LED y Neón LED / Fuentes de Alimentación Exterior 24V

M Fuentes de Alimentación Mean Well Para tiras LED



GARANTÍA 5 AÑOS



Ref	Voltaje	Pot max	Acabado	Dimensión	Material	PREZZO IVA escl.
LPV-150-12	12	150	Blanco	191X37,5X63H mm	PC	58,90
LPV-100-12	12	100	Blanco	190X52X37H mm	PC	-
LPV-60-12	12	60	Blanco	162,5X42,5X32H mm	PC	27,80
LPV-150-24	24	150	Blanco	191X37,5X63H mm	PC	94,90
LPV-100-24	24	100	Blanco	190X52X37H mm	PC	-
LPV-60-24	24	60	Blanco	162,5X42,5X32H mm	PC	27,00

1 pz conf. 25 pz scat. IP67 F.P 0,50 AC 90 264V -30°C +70°C F.P >0.50

Tiras LED y Neón LED / Fuentes de Alimentación Interior 12V

M Adaptador de Corriente Para Tiras LED 36W

GARANTÍA 3 AÑOS



Ref	Acabado	Dimensión	Material	PREZZO IVA escl.
LM2030	Negro	111X53X30 mm	Termoplastico	13,40

1 pz conf. 100 pz scat. IP20 AC 100 240V Salida DC 12V

Tiras LED y Neón LED / Fuentes de Alimentación Interior 24V

M Adaptador de Corriente Para Tiras LED 120W

GARANTÍA 3 AÑOS



Ref	Acabado	Dimensión	Material	PREZZO IVA escl.
LM2189	Negro	125X53X30 mm	Termoplastico	28,99

1 pz conf. 100 pz scat. IP20 AC 100 240V Salida DC 24V

Tiras LED y Neón LED / Fuentes de Alimentación Interior 24V

M Adaptador de Corriente Para tiras LED RGB 60W

INCLUYE CONTROL REMOTO

GARANTÍA 3 AÑOS



Ref	Acabado	Dimensión	Material	PREZZO IVA escl.
LM2190	Negro	130X55X35 mm	Termoplastico	22,90

1 pz conf. 100 pz scat. IP20 AC 100 240V Salida DC 24V

Tiras LED y Neón LED / Tiras LED 12V / Fuentes de Alimentación Interior 12V / Accesorios Tiras LED 12V

M Adaptador de Corriente Para tiras LED RGB 60W

INCLUYE CONTROL REMOTO

GARANTÍA 3 AÑOS



Ref	Acabado	Dimensión	Material	PREZZO IVA escl.
LM2032	Negro	125X55X30 mm	Termoplastico	13,70

1 pz conf.	50 pz scat.	IP20	AC 170 265V	Salida DC 12V
---------------	----------------	------	----------------	------------------

Tiras LED y Neón LED / Accesorios Tiras LED 12V / Accesorios Tiras LED 24V

M Dimmer Empotrable Táctil

GARANTÍA 3 AÑOS



Ref	Pot Max	Acabado	Corte	Dimensión	Material	Temp. de color	PREZZO IVA escl.
LM2181	96 (12V) - 192 (24V) DC	Negro	65X58 mm	86X86HX34 mm	Cristal/PC	Monocolor	26,20
LM2182	96 (12V) - 192 (24V) DC	Negro	65X58 mm	86X86HX34 mm	Cristal/PC	Rgb	26,90

1 pz conf.	50 pz scat.	IP20	12-24V DC
---------------	----------------	------	--------------

Tiras LED y Neón LED / Accesorios Tiras LED 12V / Accesorios Tiras LED 24V

M Controlador LED Táctil

INCLUYE CONTROL REMOTO

GARANTÍA 3 AÑOS



Ref	Pot Max	Acabado	Dimensión	Material	PREZZO IVA escl.
LM2102	216 (12V) - 432 (24V) DC	Negro	113X56,5X21,6 mm	PC	36,90
LM9026	216 (12V) - 432 (24V) DC	Negro	113X56,5X21,6 mm	PC	36,90

1 pz conf.	10 pz scat.	IP20	12-24V DC
---------------	----------------	------	--------------

Tiras LED y Neón LED / Accesorios Tiras LED 12V / Accesorios Tiras LED 24V

M Dimmer Monocolor Para Tiras LED

GARANTÍA 3 AÑOS



Ref	Pot Max	Acabado	Dimensión	Material	PREZZO IVA escl.
LM2179	96 (12V) - 192 (24V) DC	Blanco marfil	72X57X37H mm	PC	5,90

1 pz conf.	10 pz scat.	IP20	12-24V DC	Int. corriente 5A
---------------	----------------	------	--------------	-------------------------

Tiras LED y Neón LED / Accesorios Tiras LED 12V / Accesorios Tiras LED 24V

M Amplificador de Señal

GARANTÍA
3 AÑOS



Ref	Acabado	Dimensión	Material	PREZZO IVAescl.
LM2268	Negro	60X80X20H mm	PC	10,60

1 pz
conf.

10 pz
scat.

Int
corriente
30A

IP20

5-24V
DC

Tiras LED y Neón LED / Accesorios Tiras LED 12V / Accesorios Tiras LED 24V

M Amplificador de Señal Rgb

GARANTÍA
3 AÑOS



Ref	Acabado	Dimensión	Material	PREZZO IVAescl.
LM2269	Negro	175X110X25H mm	PC	16,60

1 pz
conf.

10 pz
scat.

Int
corriente
10X3A

IP20

5-24V
DC

Tiras LED y Neón LED / Accesorios Tiras LED 12V / Accesorios Tiras LED 24V

M Dimmer Por Infrarojos Para Tira LED

GARANTÍA
3 AÑOS



Ref	Pot max	Dimensión	Material	PREZZO IVAescl.
LM2266	60	43X12 mm	PC	9,90



VER VÍDEO

1 pz
conf.

15 pz
scat.

IP20

12-24V
DC

Tiras LED y Neón LED / Accesorios Tiras LED 12V / Accesorios Tiras LED 24V

M Interruptor Con Sensor de Movimiento Para Tira LED

GARANTÍA
3 AÑOS



Ref	Pot max	Dimensión	Material	PREZZO IVAescl.
LM2265	60	43X12 mm	PC	8,50



VER VÍDEO

1 pz
conf.

15 pz
scat.

IP20

12-24V
DC

Detección
2 m

Ángulo
360°

Tiempo
min-max
10 seg
2 min

Tiras LED y Neón LED / Accesorios Tiras LED 12V / Accesorios Tiras LED 24V

M Interruptor Táctil Para Tira LED

GARANTÍA
3 AÑOS

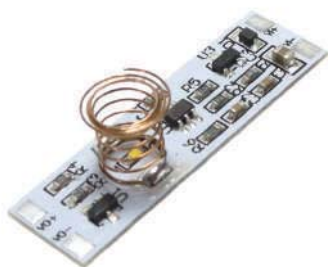

Ref	Pot max	Dimensión	Material	PREZZO IVA escl.
LM2267	60	35X10 mm	PC	8,90



1 pz conf. 30 pz scat. IP20 12-24V DC

Tiras LED y Neón LED / Accesorios Tiras LED 12V / Accesorios Tiras LED 24V

M Conector Ultramini

GARANTÍA
3 AÑOS



Ref	Pin	MM	Acabado	Dimensión	Material	PREZZO IVA escl.
LM2928	2	10	Blanco	21.6X11.5X4.3H mm	Transparente	3,20
LM2929	2 a 2 hilos	10	Blanco	15.4X11.5X4.3H mm	Transparente	3,20
LM2930	2	8	Blanco	21.6X9.5X4.3H mm	Transparente	3,20
LM2931	2 a 2 hilos	8	Blanco	15.4X9.5X4.3H mm	Transparente	3,20

1 pz conf. 20 pz scat. IP20 Int. corriente 5A

Tiras LED y Neón LED / Accesorios Tiras LED 220V / Accesorios Tiras LED 12V / Accesorios Tiras LED 24V

M Conector Intermedio Para Tira LED IP68

GARANTÍA
3 AÑOS



Ref	Pin	MM	Dimensión	Acabado	PREZZO IVA escl.
LM2922	2	10	40X15.5X8.5H mm	Transparente	3,40
LM2925	2	12	40X17.5X8.5H mm	Transparente	3,40

1 pz conf. 20 pz scat. IP68 Int. corriente 5A

Tiras LED y Neón LED / Accesorios Tiras LED 12V / Accesorios / Tiras LED 24V

M Conector Para Tira LED

GARANTÍA
3 AÑOS



Ref	Instalación	Tira	Pin	MM	Acabado	Dimensión	Material	PREZZO IVA escl.
LM2923	Inicio	IP68	2	10 Out - 8 In	Transparente	28X10.5X8.5H mm	Termoplastico	3,80
LM2926	Inicio	IP68	2	12 Out - 10 In	Transparente	28X17.5X8.5H mm	Termoplastico	3,89
LM2927	Intermedio	IP68	2	12 Out - 10 In	Transparente	28X12.5X8.5H mm	Termoplastico	4,85
LM2924	Intermedio	IP68	2	10 Out - 8 In	Transparente	28X15.5X8.5H mm	Termoplastico	5,50

1 pz conf. 20 pz scat. IP20 Int. corriente 5A

GARANTÍA
3 AÑOS

M Conector de Hipopótamo Para Tira LED



Ref	Tira	Pin	MM	Acabado	Dimensión	Material	PREZZO IVA escl.
LM2912	IP65	4	10	Negro	19.55X14.6X7.7H mm	Termoplastico	2,58
LM2914	IP65	5	12	Negro	19.55X17X7H mm	Termoplastico	2,80
LM2902	IP20	2	10	Negro	19.55X14.6X7.7H mm	Termoplastico	2,40
LM2906	IP65	2	8	Negro	19.55X12.6X7.66H mm	Termoplastico	2,30
LM2916	IP65	6	12	Negro	19.55X17X7.8H mm	Termoplastico	2,85
LM2910	IP65	3	10	Negro	19.55X14.6X7H mm	Termoplastico	2,75
LM2904	IP20	3	10	Negro	19.55X14.6X7H mm	Termoplastico	2,75
LM2908	IP65	2	10	Negro	19.55X14.6X7.7H mm	Termoplastico	2,40

20 pz
conf.

100 pz
scat.

IP20

Int.
corriente
5A

GARANTÍA
3 AÑOS

M Conector de Hipopótamo Para Tira LED y Cable



Ref	Tira	Pin	MM	Acabado	Dimensión	Material	PREZZO IVA escl.
LM2909	IP65	3	10	Negro	24.3X14.6X7.2H mm	Transparente	2,65
LM2913	IP65	5	12	Negro	24.3X17X7.2H mm	Transparente	2,85
LM2903	IP20	3	10	Negro	24.3X14.6X7.2H mm	Transparente	2,75
LM2915	IP65	6	12	Negro	24.7X17X7.2H mm	Transparente	2,90
LM2911	IP65	4	10	Negro	24.3X14.6X7.7H mm	Transparente	2,80
LM2905	IP65	2	8	Negro	24.7X12.6X7.66H mm	Transparente	2,10
LM2907	IP65	2	10	Negro	24.3X14.6X7.7H mm	Transparente	2,20
LM2901	IP20	2	10	Negro	24.3X14.6X7.7H mm	Transparente	2,20

conf.

scat.

20 pz

100 pz

IP20

Int.
corriente
5A

GARANTÍA
3 AÑOS

M Conector de Hipopótamo Tipo L Para Tira LED



Ref	Tira	Pin	MM	Acabado	Dimensión	Material	PREZZO IVA escl.
LM2917	IP20	2	10	Negro	26.9X26.9X7.7H mm	Transparente	4,90
LM2919	IP65	4	10	Negro	26.9X26.9X7.7H mm	Transparente	4,95
LM2903	IP20	3	10	Negro	26.9X26.9X7.7H mm	Transparente	4,95

conf.

scat.

20 pz

100 pz

IP20

Int.
corriente
5A

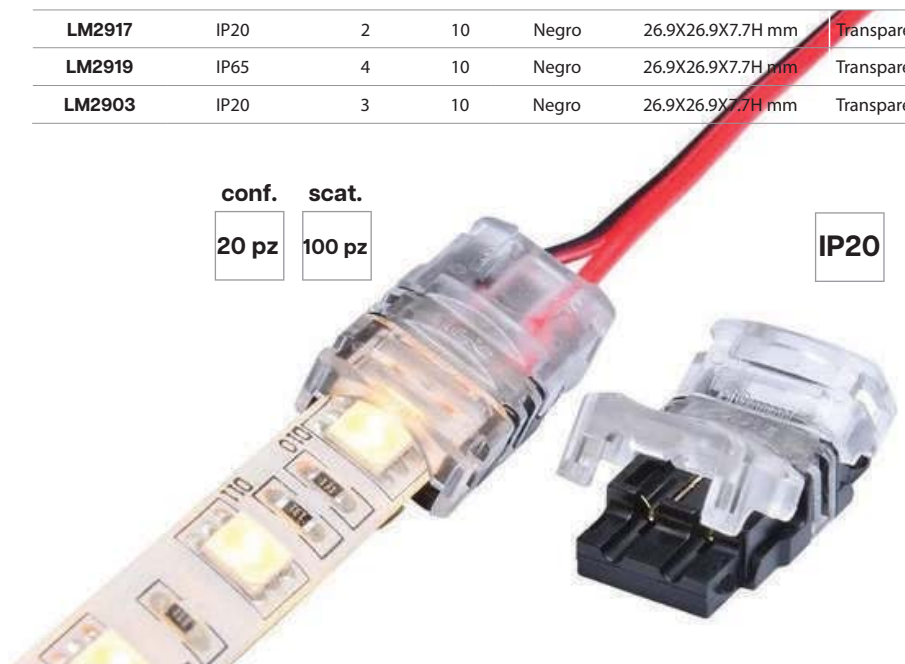

Tiras LED y Neón LED / Accesorios Tiras LED 220V / Accesorios Tiras LED 12V / Accesorios Tiras LED 24V

M Roldana para Tiras LED

GARANTÍA
3 AÑOS



Ref	Material	Dimensión	PREZZO IVAescl.
LM0010	Aluminio/PC	235X45H mm	27,90

conf.	scat.
1 pz	10 pz

Tiras LED y Neón LED / Accesorios Tiras LED 12V / Accesorios Tiras LED 24V

M Controlador Mini Para Tiras LED Rgb

INCLUYE
CONTROL
REMOTO

GARANTÍA
3 AÑOS



Ref	Pot Max	Acabado	Dimensión	Material	PREZZO IVAescl.
LM2185	144 (12V) - 288 (24V) DC	Blanco	62X35X23H mm	Aluminio/PC	5,70

conf.	scat.
1 pz	15 pz

IP20 12-24V DC

Tiras LED y Neón LED / Accesorios Tiras LED 12V / Accesorios Tiras LED 24V

M Controlador Mini Smarthome Para Tiras LED Rgb

INCLUYE
APP

INCLUYE
CONTROL
REMOTO

GARANTÍA
3 AÑOS



Ref	Pot Max	Acabado	Dimensión	Material	PREZZO IVAescl.
LM2187	72 (12V) - 144 (24V) DC	Blanco	50X22X10H mm	PC	27,50

conf.	scat.
1 pz	10 pz

IP20 12-24V DC wifi 2.4 Ghz

Tiras LED y Neón LED / Accesorios Tiras LED 12V / Accesorios Tiras LED 24V

M Controlador LED Táctil Rgb+Cct

INCLUYE
CONTROL
REMOTO

GARANTÍA
3 AÑOS



Ref	Pot Max	Acabado	Dimensión	Material	PREZZO IVAescl.
LM2101	216 (12V) - 432 (24V) DC	Blanco	85X45X25H mm	PC	44,90

conf.	scat.
1 pz	10 pz

IP20 5-24V DC

Tiras LED y Neón LED / Accesorios Tiras LED 12V / Accesorios Tiras LED 24V

M Controlador Mini Para Tiras LED Cct

INCLUYE CONTROL REMOTO

GARANTÍA 3 AÑOS



Ref	Pot Max	Acabado	Dimensión	Material	PREZZO IVAescl.
LM2188	96 (12V) - 192 (24V) DC	Blanco	50X35X22H mm	PC	9,60

conf.	scat.
1 pz	10 pz

IP20 12-24V DC

Tiras LED y Neón LED / Accesorios Tiras LED 12V / Accesorios Tiras LED 24V

M Controlador Wifi Para Tiras LED Rgb+Cct

INCLUYE APP

INCLUYE CONTROL REMOTO

GARANTÍA 3 AÑOS



Ref	Pot Max	Acabado	Dimensión	Material	PREZZO IVAescl.
LM2460	72 (12V) - 144 (24V) DC	Blanco	48X33X17H mm	PC	22,90

conf.	scat.
1 pz	10 pz

IP20 5-24V DC wifi 2.4 GHz

Tiras LED y Neón LED / Accesorios Tiras LED 12V

M Controlador Mini Para Tiras LED Rgb

INCLUYE CONTROL REMOTO

GARANTÍA 3 AÑOS



Ref	Pot Max	Acabado	Dimensión	Material	PREZZO IVAescl.
LM2184	144(12V)	Blanco	62X35X23H mm	PC	4,20

conf.	scat.
1 pz	15 pz

IP20 12V DC

Tiras LED y Neón LED / Accesorios Tiras LED 12V / Accesorios Tiras LED 24V

M Controlador Mini Para Tiras LED Rgbw

INCLUYE APP

INCLUYE CONTROL REMOTO

GARANTÍA 3 AÑOS



Ref	Pot Max	Acabado	Dimensión	Material	PREZZO IVAescl.
LM2180	144 (12V) - 288 (24V) DC	Blanco	50X22X10H mm	PC	31,00

conf.	scat.
1 pz	10 pz

IP20 12-24V DC wifi 2.4 GHz

Tiras LED y Neón LED / Accesorios Tiras LED 12V / Accesorios Tiras LED 24V

M Controlador Para Tiras LED Rgb+C/rgb+W

INCLUYE CONTROL REMOTO

GARANTÍA 3 AÑOS



Ref	Pot Max	Acabado	Dimensión	Material	PREZZO IVAescl.
LM2457	72 (12V) - 144 (24V) DC	Blanco	33X48X22H mm	PC	7,20

conf.	scat.		
1 pz	10 pz	IP20	12-24V DC

Tiras LED y Neón LED / Accesorios Tiras LED 12V / Accesorios Tiras LED 24V

M Controlador Wifi Para Tiras LED Rgb+C/rgb+W

INCLUYE CONTROL REMOTO

GARANTÍA 3 AÑOS



Ref	Pot Max	Acabado	Dimensión	Material	PREZZO IVAescl.
LM2458	72 (12V) - 144 (24V) DC	Blanco	34X65X15H mm	PC	20,50

conf.	scat.			
1 pz	10 pz	IP20	12V DC	Int. corriente 5A

Tiras LED y Neón LED / Accesorios Tiras LED 12V / Accesorios Tiras LED 24V

M Controlador Wifi Rgb+Cct App Magic Home

INCLUYE APP

GARANTÍA 3 AÑOS



Ref	Pot Max	Acabado	Dimensión	Material	PREZZO IVAescl.
LM2186	96 (12V) - 192 (24V) DC	Blanco	83X63X17H mm	Metal/PC	42,00

conf.	scat.			
1 pz	10 pz	IP20	12-24V DC	Int. corriente 5A

Tiras LED y Neón LED / Accesorios Tiras LED 220V

M Controlador Para Tiras LED Rgb Fast

INCLUYE PIN Y TAPÓN

INCLUYE CONTROL REMOTO

GARANTÍA 3 AÑOS



Ref	Pot Max	Acabado	Dimensión	Material	PREZZO IVAescl.
LM2311	700W	Blanco	90X60 mm	Aluminio/PC	16,20

conf.	scat.		
1 pz	10 pz	IP65	AC 170 265V

Tiras LED y Neón LED / Accesorios Tiras LED 220V

M Controlador LED Rgb Fast 220V

INCLUYE
PIN Y
TAPÓN

GARANTÍA
3 AÑOS



Ref	Acabado	Dimensión	Material	PREZZO IVA escl.
LM2312	Blanco	90X60 mm	Termoplastico	7,40

conf.

scat.

1 pz

15 pz

IP65

AC 220
240V

Tiras LED y Neón LED / Accesorios Tiras LED 220V

M Controlador Neón Led Rgb 220V

INCLUYE
PIN Y
TAPÓN

GARANTÍA
3 AÑOS



Ref	Acabado	Dimensión	Material	PREZZO IVA escl.
LM2160	Blanco	90X60 mm	Termoplastico	8,50

conf.

scat.

1 pz

15 pz

IP65

AC 170
265V

Tiras LED y Neón LED / Accesorios Tiras LED 220V

M Controlador Para Tira LED 220V Mixt

INCLUYE
PIN Y
TAPÓN

GARANTÍA
3 AÑOS



Ref	Acabado	Dimensión	Material	PREZZO IVA escl.
LM2039	Blanco	90X60 mm	Termoplastico	6,20

conf.

scat.

1 pz

15 pz

IP65

AC 170
265V

Tiras LED y Neón LED / Accesorios Tiras LED 220V

M Rectificador Tira LED 220V Smd 2835 Fast

INCLUYE
PIN Y
TAPÓN

GARANTÍA
3 AÑOS



Ref	Acabado	Dimensión	Material	PREZZO IVA escl.
LM2310	Blanco	12X12X600 mm	Termoplastico	4,60

conf.

scat.

1 pz

15 pz

IP65

AC 170

Tiras LED y Neón LED / Accesorios Tiras LED 220V

M Rectificador Tira LED 220V Smd 2835 Arast

INCLUYE
PIN Y TA-
PÓN

GARANTÍA
3 AÑOS



Ref	Acabado	Dimensión	Material	PREZZO IVA escl.
LM2313	Blanco	12X12X600 mm	Termoplastico	4,50

conf.	scat.	IP65	AC 170 265V
1 pz	15 pz		

Tiras LED y Neón LED / Accesorios Tiras LED 220V

M Rectificador Neón LED Monocolor 220V

INCLUYE
PIN Y TA-
PÓN

GARANTÍA
3 AÑOS



Ref	Acabado	Dimensión	Material	PREZZO IVA escl.
LM2158	Amarillo	12X12X600 mm	Termoplastico	5,30

conf.	scat.	IP65	AC 170 265V
1 pz	15 pz		

Tiras LED y Neón LED / Accesorios Tiras LED 12V

M Controlador M-4000 Para Tira LED Digital Ritt / Messe

INCLUYE
SD

INCLUYE
CARGADOR

GARANTÍA
3 AÑOS



Ref	Vatios	Nº de canales	Acabado	Dimensión	Material	PREZZO IVA escl.
KB2042	2	4096 LED Pixel IC	Blanco	170X115X30H mm	Aluminio	623,00

conf.	scat.	IP20	5-12 24V DC
1 pz	5 pz		

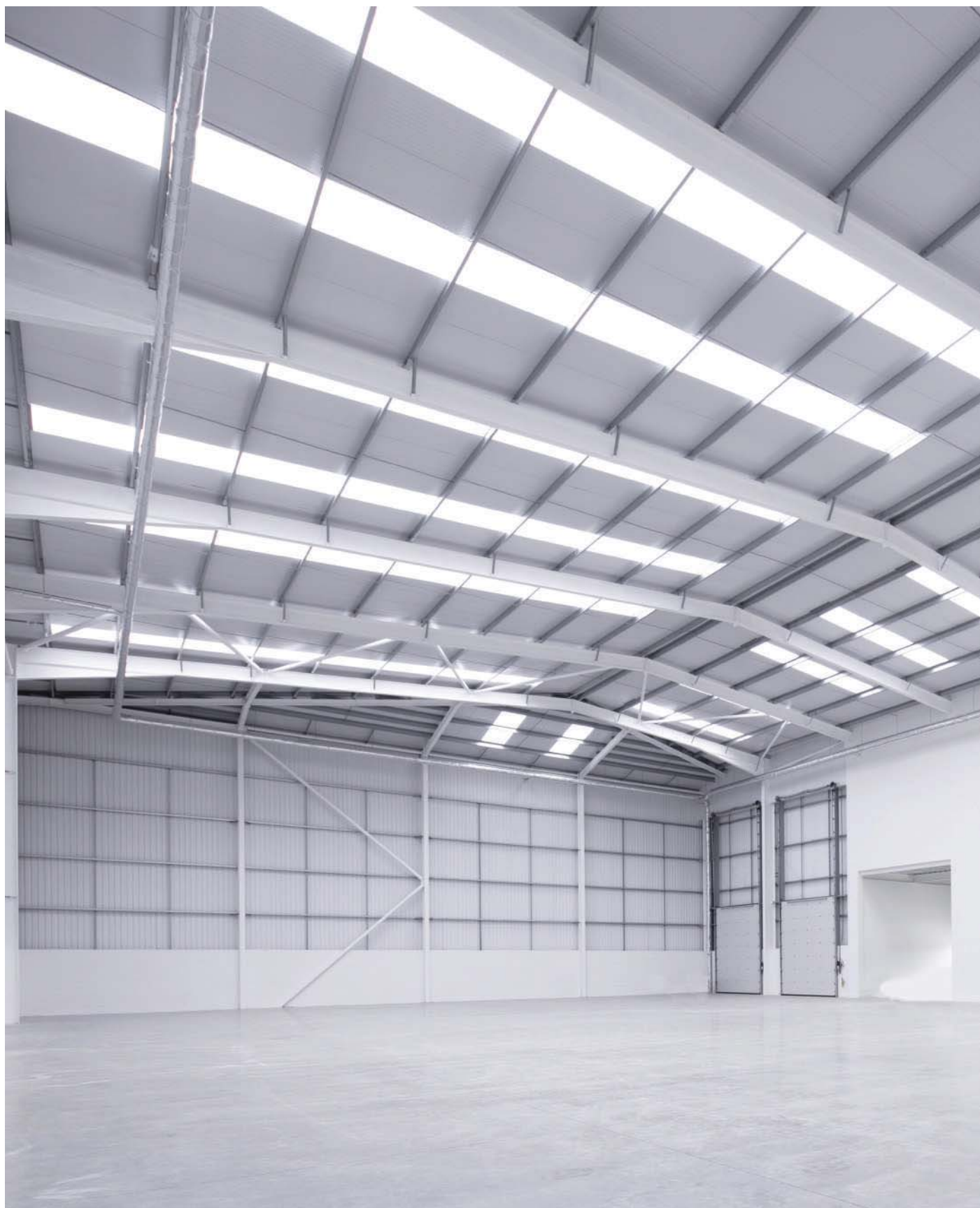

ILUMINACIÓN INDUSTRIAL



Ref	Vatios	Lm	Acabado	Dimensión	Material	Temperatura de color	PREZZO IVA escl.
LM6733	100 W	16000	Negro	280X280X120H mm	Aluminio / PMMA	5700 K	174,00
LM6734	100 W	16000	Negro	280X280X120H mm	Aluminio / PMMA	4500 K	174,00
LM6735	150 W	24000	Negro	340X340X125H mm	Aluminio / PMMA	5700 K	205,00
LM6736	150 W	24000	Negro	340X340X125H mm	Aluminio / PMMA	4500 K	205,00
LM6737	200 W	32000	Negro	410X410X140H mm	Aluminio / PMMA	5700 K	253,00
LM6738	200 W	32000	Negro	410X410X140H mm	Aluminio / PMMA	4500 K	253,00

1 pz conf.	1 pz scat.	IP67	40000 H	AC 85 265V	IK10	90°	-20°C + 45°C	CRI 85	F.P 0.95	KV 6
---------------	---------------	------	---------	---------------	------	-----	-----------------	-----------	-------------	---------

Transmisión de luz es superior al **90%**.
 Eficiencia lumínica superior a **160 lm/w.**
 Distribución lumínica **90°**.

TIPOS DE MONTAJE



M Iluminación Industrial
Campana LED SMD Cool



**GARANTÍA
3 AÑOS**



Ref	Vatios	Lm	Acabado	Dimensión	Material	Temperatura de color	PREZZO IVA escl.
LM6771	100 W	12000	Aluminio	430X310H mm	Aluminio	5000 K	88,00
LM6772	100 W	12000	Aluminio	430X310H mm	Aluminio	4000 K	88,00
LM6773	100 W	12000	Aluminio	430X310H mm	Aluminio	3000 K	88,00
LM6774	150 W	18000	Aluminio	430X310H mm	Aluminio	5000 K	120,00
LM6775	150 W	18000	Aluminio	430X310H mm	Aluminio	4000 K	120,00
LM6776	150 W	18000	Aluminio	430X310H mm	Aluminio	3000 K	120,00
LM6777	200 W	24000	Aluminio	430X310H mm	Aluminio	5000 K	154,00
LM6778	200 W	24000	Aluminio	430X310H mm	Aluminio	4000 K	154,00
LM6779	200 W	24000	Aluminio	430X310H mm	Aluminio	3000 K	154,00

1 pz conf.	1 pz scat.	IP44	30000 H	AC 85 265V	IK6	120°	-20°C + 45°C	CRI 80	F.P 0.95	KV 4
---------------	---------------	------	---------	---------------	-----	------	-----------------	-----------	-------------	---------

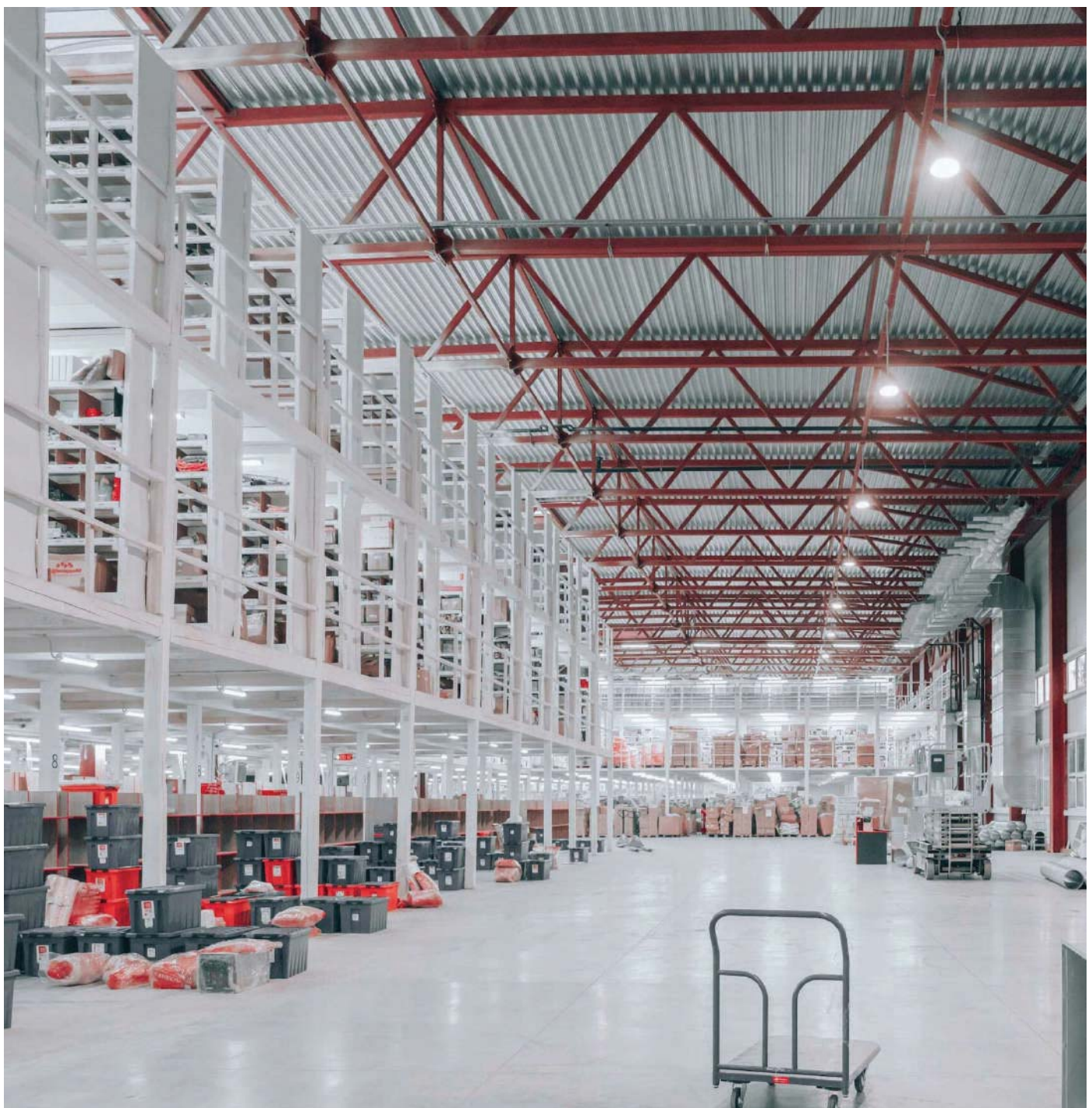



Ref	Vatios	Acabado	Dimensión	Material	PREZZO IVA escl.
LM9010	25 W	Negro	320X160 mm	Metal/PC	122,00

conf.	scat.	IP65	AC 220 240V	EXTENSIÓN 0-10M	PESO MAX. 10 kg
1 pz	1 pz				

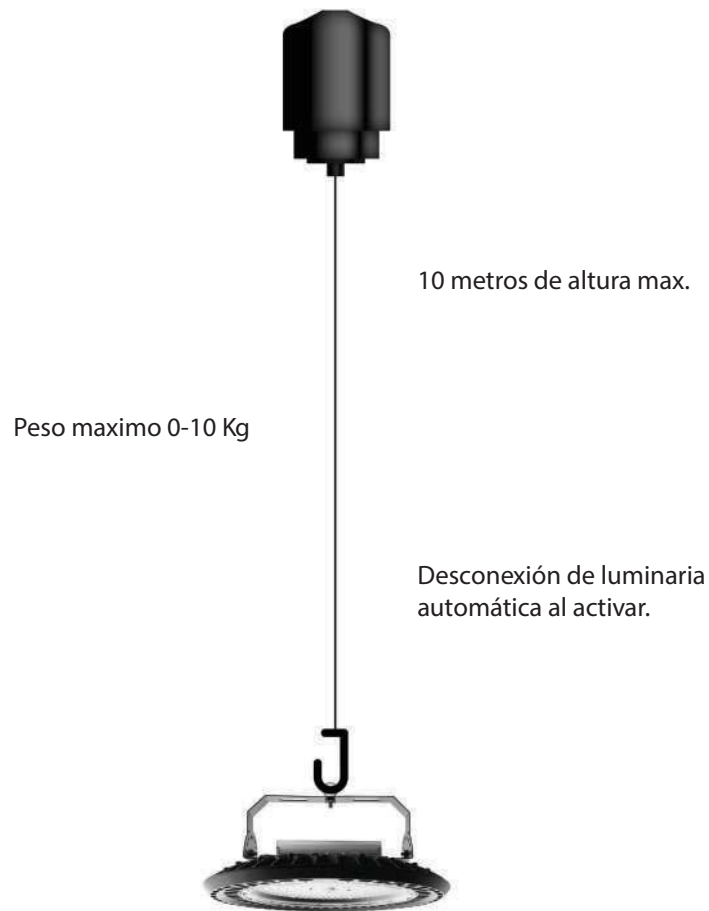

Un día día más fácil

El elevador para luminarias LED, está pensado para realizarnos un mantenimiento más sencillo, libre de plataformas elevadoras o de posibles riesgos laborales provocados por trabajos realizados en altura.

Cada Elevador de Campanas dispone de un control remoto único por radiofrecuencia.

El control remoto nos permite un alcance de hasta 25 metros de distancia, cada frecuencia es única, permitiéndonos una única conexión por cada elevador, garantizaremos que se puedan manejar

de manera individual cada elevador y no se realice un control por grupos, evitando que se haga uso de otros elevadores que no sea necesaria su utilización en el momento.

La luminaria quedará libre de tensión en el momento que la comience a descolgarse, de esa manera podremos garantizar un trabajo seguro, con la finalidad de evitar riesgos eléctricos.

El peso máximo a soportar por la luminaria es de 7,5 kg.



Ver vídeo

M Iluminación Industrial
Campana UFO LED Serie A 1-10V



**GARANTÍA
7 AÑOS**



Accesorios



Pasarela Convertor
1-10V 2 Hilos A Dali
LF-SCD010B

Ref	Vatios	Lm	Acabado	Dimensión	Material	Temperatura de color	PREZZO IVA escl.
GA6761	100 W	18000	Negro	253X149H mm	Aluminio	5000 K	120,00
GA6762	100 W	18000	Negro	253X149H mm	Aluminio	4000 K	120,00
GA6763	150 W	27000	Negro	308X155H mm	Aluminio	5000 K	135,00
GA6764	150 W	27000	Negro	308X155H mm	Aluminio	4000 K	135,00
GA6765	200 W	36000	Negro	354X160H mm	Aluminio	5000 K	172,00
GA6766	200 W	36000	Negro	354X160H mm	Aluminio	4000 K	172,00
GA6769	300 W	54000	Negro	400X210H mm	Aluminio	5000 K	277,00
GA6770	300 W	54000	Negro	400X210H mm	Aluminio	4000 K	277,00

conf. scat.

1 pz	1 pz	IP65	70000 H	AC 220 240V	IK8	90°	-20°C + 45°C	CRI 70	F.P 0.95	KV 4
------	------	-------------	---------	----------------	------------	------------	-----------------	-------------------	---------------------	-----------------

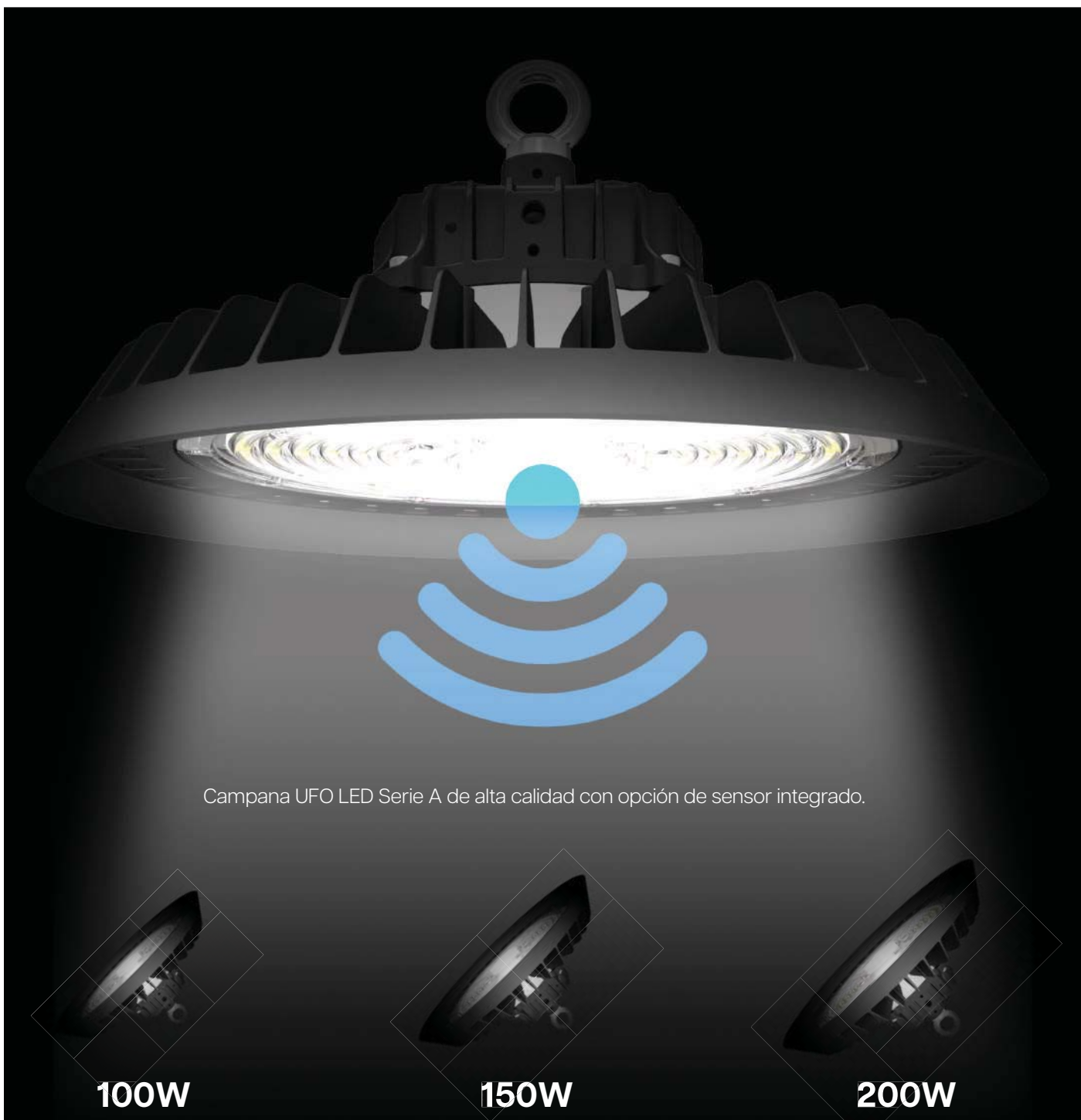

Campana UFO LED Serie A de alta calidad con opción de sensor integrado.

100W

150W

200W



Mando Control Para Campana Serie A



FUNCIÓN ON/OFF

Presionar el botón "ON / OFF" pasa al modo de encendido permanente o apagado.

- Presione los botones "Modo automático", "Reiniciar" o "Modo de escena" para salir de este modo.

Auto Mode

MODO SENSOR

Presione el botón "Modo automático", el sensor comenzará a funcionar y todas las configuraciones permanecerán igual que el último estado antes de que se encendiera o apagara la luz.



FUNCIÓN RESET

Presione el botón "RESET", todas las configuraciones volverán al valor de las configuraciones del interruptor DIP.



Dim +/-

Mantenga presionado "Dim +" "Dim -" para ajustar el brillo de la luz durante el tiempo de espera. "+" significa atenuación ascendente, "-" significa atenuación descendente.



MODO TEST

El botón "Test 2s" es solo para fines de prueba. El sensor pasa al modo de prueba (el tiempo de espera es de 2 s) automáticamente después de la puesta en marcha, mientras que el período de espera y el sensor de luz diurna están desactivados.

Este modo se puede finalizar presionando "reiniciar" o cualquier botón de "modo de escena" y "tiempo de espera". El ajuste del sensor se cambia en consecuencia.



SALIDA DE POTENCIA

Presione estos botones para seleccionar el nivel de salida completo. El botón del 80% permite el ahorro de energía y la atenuación inversa para compensar la depreciación del lumen del LED con el tiempo. Admite **bur-in** inicial fluorescente de **10.000 hr.**



DESHABILITAR LUX

Presione este botón para desactivar el sensor de luz diurna para el control de umbral. Cuando se detecta movimiento, el dispositivo siempre se encenderá, independientemente del nivel de la luz ambiental.

MODO ESCENA

Hay cuatro programas fijos de modos de escena integrados en el control remoto. Seleccione según corresponda. Cada escena se puede modificar usando el control remoto. El sensor recordará las actualizaciones incluso después de un corte de energía. El botón verde "RESET" en el control remoto vuelve a los valores predeterminados originales.

NOTA: El usuario final puede ajustar la configuración presionando los botones de rango de detección/tiempo de espera/período de espera/nivel de atenuación de espera/sensor de luz diurna. La última configuración permanece en vigencia.

Escena	Rango	Espera	Stand-by	Stand-by nivel	Sensor de luz diurna
SC1	100%	1 min	10 min	10%	2 Lux
SC2	100%	5 min	10 min	10%	2 Lux
SC3	100%	10 min	30 m in	10%	10 Lux
SC4	100%	10 min	+∞	10%	50 Lux

RANGO DE DETECCION

Seleccione según corresponda para ajustar/reducir la sensibilidad del sensor, rango de detección del 100 %. Consulte el patrón de detección.

Iluminación Industrial
M **Campana LED Infinity**



GARANTÍA
5 AÑOS



Ref	Vatios	Lm	Acabado	Dimensión	Material	Temperatura de color	PREZCO IVA escl.
LM6751	100 W	12000	Gris	283X253H mm	Aluminio	6000 K	89,00
LM6753	150 W	18000	Gris	308X253H mm	Aluminio	6000 K	128,00
LM6755	200 W	24000	Gris	336X253H mm	Aluminio	6000 K	162,00

conf. scat.

1 pz	1 pz	IP44	50000 H	AC 100 265V	IK8	90° 120° sin difusor	-20°C + 45°C	CRI 70	F.P 0.95	KV 2
------	------	------	---------	----------------	-----	----------------------------	-----------------	-----------	-------------	---------



DIFUSOR OPCIONAL INCLUIDO





ALUMBRADO PÚBLICO

Alumbrado Público

M Farola LED Light Series Pro



Ref	Vatios	Lm	Acabado	Dimensión	Material	Temperatura de color	PREZZO IVA escl.
LM6450	50	4500	Gris	466X565H mm	Aluminio / Cristal	5000 K	287,00
LM6451	50	4500	Gris	466X565H mm	Aluminio / Cristal	4500 K	287,00

conf. scat.

1 pz	1 pz	IP65	50000 H	AC 120 277V	IK8	120°	-30°C + 50°C	CRI 70	F.P 0.90	Detección 360°	Fijación 70 mm
------	------	------	---------	-------------	-----	------	--------------	--------	----------	----------------	----------------

Accesorios



Anulador de fotocélula
LM6450



Nivel de encendido
10-16 Lux



Alumbrado Público

M Farola Solar LED Solights Para Alumbrado Público

INCLUYE
CONTROL
REMOTO

LED
provided by
SANAN

GARANTÍA
3 AÑOS



Ref	Vatios	Lm	Acabado	Dimensión	Material	Temperatura de color	PREZZO IVA escl.
LM6540	100	6300	Gris	288X130X550H mm	Aluminio / PMMA	4000 K	218,00
LM6541	100	6300	Gris	288X130X550H mm	Aluminio / PMMA	6000 K	218,00
LM6542	100	6300	Gris	288X130X550H mm	Aluminio / PMMA	2700 K	218,00
LM6545	200	12600	Gris	322X130X660H mm	Aluminio / PMMA	6000 K	255,00
LM6544	200	12600	Gris	322X130X660H mm	Aluminio / PMMA	4000 K	255,00
LM6545	200	12600	Gris	322X130X660H mm	Aluminio / PMMA	2700 K	255,00
LM6546	300	18900	Gris	350X155X855H mm	Aluminio / PMMA	6000 K	372,00
LM6547	300	18900	Gris	350X155X855H mm	Aluminio / PMMA	4000 K	372,00
LM6548	300	18900	Gris	350X155X855H mm	Aluminio / PMMA	2700 K	372,00

conf. scat.

1 pz

1 pz

IP65

40000 H

IK8

140°X75°

-30°C
+ 60°C

CRI
70

Carga
6-8 Hr

Uso
10-12 Hr

Sensor
Crepuscular
Movimiento



Sincronizando necesidades

ON: Encendido de farola

OFF: Apagado de farola

+: Aumentar intensidad

-: Reducir intensidad

AUTO: Encendido a partir de 10-16 lux al 100%, el nivel de intensidad se verá afectado según el nivel de carga de la batería.

3H: Funcionamiento al 100% durante 3 horas, pasado ese tiempo apagado total.

5H: Funcionamiento al 100% durante 5 horas, pasado ese tiempo apagado total.

8H: Funcionamiento al 100% durante 8 horas, pasado ese tiempo apagado total.

: Aumentar intensidad

: Reducir intensidad



Alumbrado Público

M Farola Solar LED Urban Para Alumbrado Público

INCLUYE
CONTROL
REMOTO

LED
provided by
bridgelux

GARANTÍA
3 AÑOS



Ref	Vatios	Lm	Batería	Acabado	Dimensión	Material	Temperatura de color	PREZZO IVA escl.
LM6371	60	4200	3.2V 15000mAh	Gris	530X900H mm	Aluminio / PMMA	6000K	223,00
LM6372	100	7000	3.2V 20000mAh	Gris	700X990H mm	Aluminio / PMMA	6000K	275,00
LM6373	200	14000	3.2V 30000mAh	Gris	670X995H mm	Aluminio / PMMA	6000K	347,00

conf. scat.

1 pz	1 pz	IP65	30000 H	140°X75°	-30°C + 50°C	CRI 75	Carga 6-8 Hr	Uso 18-10 Hr	Sensor Crepuscular
------	------	------	---------	----------	-----------------	-----------	-----------------	-----------------	-----------------------

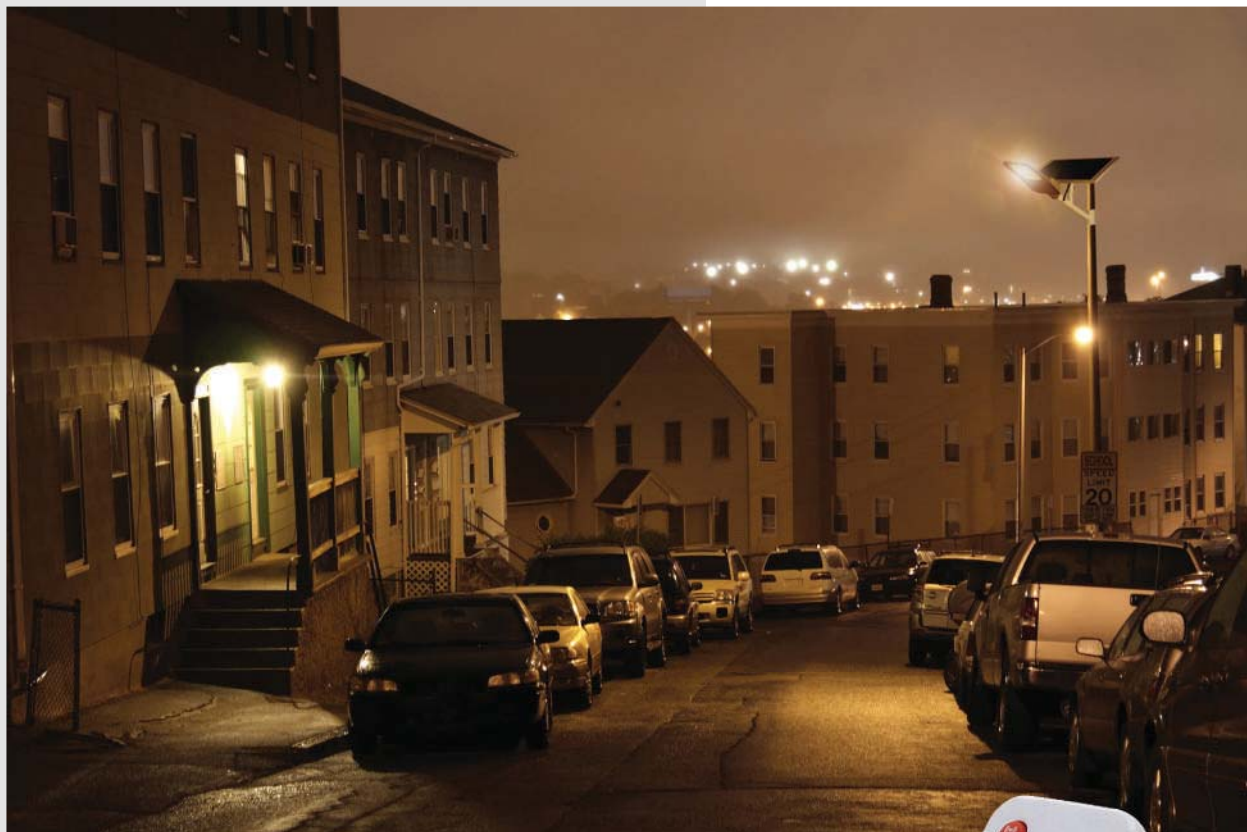

Sincronizando necesidades

ON: Encendido de farola

OFF: Apagado de farola

+: Aumentar intensidad

-: Reducir intensidad

AUTO: Encendido a partir de 10-16 lux al 100%, el nivel de intensidad se verá afectado según el nivel de carga de la batería.

3H: Funcionamiento al 100% durante 3 horas, acabado ese tiempo vuelve al modo auto.

5H: Funcionamiento al 100% durante 5 horas, acabado ese tiempo vuelve al modo auto.

8H: Funcionamiento al 100% durante 8 horas, acabado ese tiempo vuelve al modo auto.





Alumbrado Público

Farola Solar LED

Para Alumbrado Público con Sensor



Ref	Vatios	Lm	Batería	Acabado	Dimensión	Material	Temperatura de color	PREZZO IVA escl.
LM6368	20	1500	3.2V 5000mAh	Gris	200X390H mm	ABS / Aluminio	6000K	58,00
LM6369	40	3000	3.2V 10000mAh	Gris	230X500H mm	ABS / Aluminio	6000K	85,00
LM6370	60	4500	3.2V 15000mAh	Gris	240X620H mm	ABS / Aluminio	6000K	97,00

conf. scat.

1 pz	1 pz	IP65	50000 H	140°X75°	-30°C + 50°C	CRI 80	Carga 6-8 Hr	Uso 6-8 Hr	Sensor Crepuscular Movimiento	Fijación 50 mm
------	------	------	---------	----------	-----------------	-----------	-----------------	---------------	-------------------------------------	-------------------



Sincronizando necesidades

ON/OFF: Encendido y apagado de farola

2H NO SEN: Funcionamiento al 100% durante 2 horas.

3H NO SEN: Funcionamiento al 100% durante 3 horas.

4H NO SEN: Funcionamiento al 100% durante 4 horas.

AUTO: Encendido a partir de 10-16 lux al 100%, el nivel de intensidad se verá afectado según el nivel de carga de la batería.

⊖: Reducir intensidad (Solo para modo AUTO)

⊕: Aumentar intensidad (Solo para modo AUTO)

RADAR: Modo con sensor, funcionamiento del 100% durante 10 segundos aproximadamente, en el momento de no detectar movimiento se reduce al 25%.



Brazo articulado
LM6255

prezzo
IVA escl.
36,00



Soporte de pared
LM6657A

prezzo
IVA escl.
16,90



Alumbrado Público

M Farol Villa Acero Pintado Horno Negro

GARANTÍA
3 AÑOS



Ref	Acabado	Dimensión	Material	PREZZO IVA escl.
LM6443	Negro	410X410X120H mm	Acero	173,00

conf.	scat.
1 pz	IP20



Alumbrado clásico e innovador

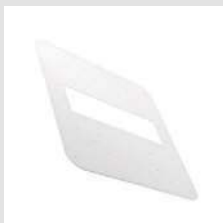

Chapa Adaptación
LM6444

prezzo
IVA escl.
11,15



Chapa Adaptación doble
LM6445

prezzo
IVA escl.
11,15



Optica 145°x70°
LM6315

prezzo
IVA escl.
10,50



Foco Modular Led Speed
50W
LM6311 - 6000K
LM6312 - 4500K
LM6313 - 3000K

prezzo
IVA escl.
33,90
33,90
33,90



Driver Meanwell Xlg-50-A
50W
LM2105



Driver Para Foco Modular
Led Speed 50W
LM6314

prezzo
IVA escl.
14,50

Alumbrado Público

M Farola Solar LED Kain Para Alumbrado Público



Ref	Vatios	Lm	Acabado	Dimensión	Material	Temperatura de color	PREZIO IVAescl.
LM6535	80	4400	Negro	410X410X120H mm	Aluminio / PMMA	6000K	219,00



conf. scat.

1 pz	5 pz	IP65	30000 H	120°	-30°C + 50°C	120°	CRI 75	Carga 6-8 Hr	Uso 10-12 Hr	Sensor Crepuscular Movimiento	Fijación 60 mm
------	------	------	---------	------	-----------------	------	-----------	-----------------	-----------------	-------------------------------------	-------------------

Sincronizando necesidades

ON/OFF: Encendido y apagado de farola

2H NO SEN: Funcionamiento al 100% durante 2 horas.

3H NO SEN: Funcionamiento al 100% durante 3 horas.

4H NO SEN: Funcionamiento al 100% durante 4 horas.

AUTO : Encendido a partir de 10-16 lux al 100%, el nivel de intensidad se verá afectado según el nivel de carga de la batería.

⚙️ -: Reducir intensidad (Solo para modo AUTO)

⚙️ +: Aumentar intensidad (Solo para modo AUTO)

RADAR: Modo con sensor, funcionamiento del 100% durante 10 segundos aproximadamente, en el momento de no detectar movimiento se reduce al 50%.



Alumbrado Público

M Farola LED Serie Harlem



GARANTÍA
3 AÑOS



Ref	Vatios	Lm	Acabado	Dimensión	Material	Temperatura de color	PREZZO IVA escl.
LM6551	50	5500	Gris	160X390H mm	Aluminio / PMMA	5000 K	50,00
LM6552	50	5500	Gris	160X390H mm	Aluminio / PMMA	4000 K	50,00
LM6553	50	5500	Gris	160X390H mm	Aluminio / PMMA	2700 K	50,00
LM6554	100	11000	Gris	200X470H mm	Aluminio / PMMA	5000 K	76,00
LM6555	100	11000	Gris	200X470H mm	Aluminio / PMMA	4000 K	76,00
LM6556	100	11000	Gris	200X470H mm	Aluminio / PMMA	2700 K	76,00
LM6557	150	16500	Gris	220X530H mm	Aluminio / PMMA	5000 K	102,00
LM6558	150	16500	Gris	220X530H mm	Aluminio / PMMA	4000 K	102,00
LM6559	150	16500	Gris	220X530H mm	Aluminio / PMMA	2700 K	102,00
LM6560	200	22000	Gris	250X600H mm	Aluminio / PMMA	5000 K	145,00
LM6561	200	22000	Gris	250X600H mm	Aluminio / PMMA	4000 K	145,00
LM6562	200	22000	Gris	250X600H mm	Aluminio / PMMA	2700 K	145,00

Accesorios



conf. scat.

1 pz	1 pz	IP65	30000 H	AC 200 240V	IK8	140°X75°	-20°C + 45°C	CRI 70	F.P 0.90	Fijación 60 mm
------	------	------	---------	----------------	-----	----------	-----------------	-----------	-------------	-------------------





Ref	Vatios	Lm	Acabado	Dimensión	Material	Temperatura de color	PREZZO IVA escl.
LM6901	30	4200	RAL 9006	200X109X568H mm	ABS / Aluminio	5000K	258,00
LM6902	30	4200	RAL 9006	200X109X568H mm	ABS / Aluminio	4000K	258,00
LM6903	30	4200	RAL 9006	200X109X568H mm	ABS / Aluminio	2700K	258,00
LM6904	60	8400	RAL 9006	200X109X568H mm	ABS / Aluminio	5000K	283,00
LM6905	60	8400	RAL 9006	200X109X568H mm	ABS / Aluminio	4000K	283,00
LM6906	60	8400	RAL 9006	200X109X568H mm	ABS / Aluminio	2700K	283,00
LM6907	90	12600	RAL 9006	240X109X613H mm	ABS / Aluminio	5000K	319,00
LM6908	90	12600	RAL 9006	240X109X613H mm	ABS / Aluminio	4000K	319,00
LM6909	90	12600	RAL 9006	240X109X613H mm	ABS / Aluminio	2700K	319,00

Accesorios



conf. scat.

1 pz	1 pz	IP65	50000 H	AC 100 240V	IK8	150°X70°	-20°C + 45°C	CRI 80	F.P 0.90	KV 10	Fijación 60 mm	Regulable 1-10v
------	------	------	---------	-------------	-----	----------	--------------	--------	----------	-------	----------------	-----------------



Instalación

Farola con brazo articulado, el brazo articulado nos permite distintos tipos de instalación.

En vertical o horizontal, ya que el mismo se adapta a cualquier tipo de instalación, el diametro de fijación es de 60 mm.



Driver Sosen

SS-40VA-T50B es un controlador LED de corriente constante de **40W de la prestigiosa marca Sosen**

Dispone de protección frente a cortocircuitos, protección contra sobrecarga y protección contra sobrecalentamiento.

Dispone de una garantía de 5 años ofrecida por el mismo fabricante.



Nivel

Esta farola esta equipada en su parte central con un nivel para para facilitar su instalación.

Gracias a este sistema el cabezal permanecera totalmente en la posición deseada.

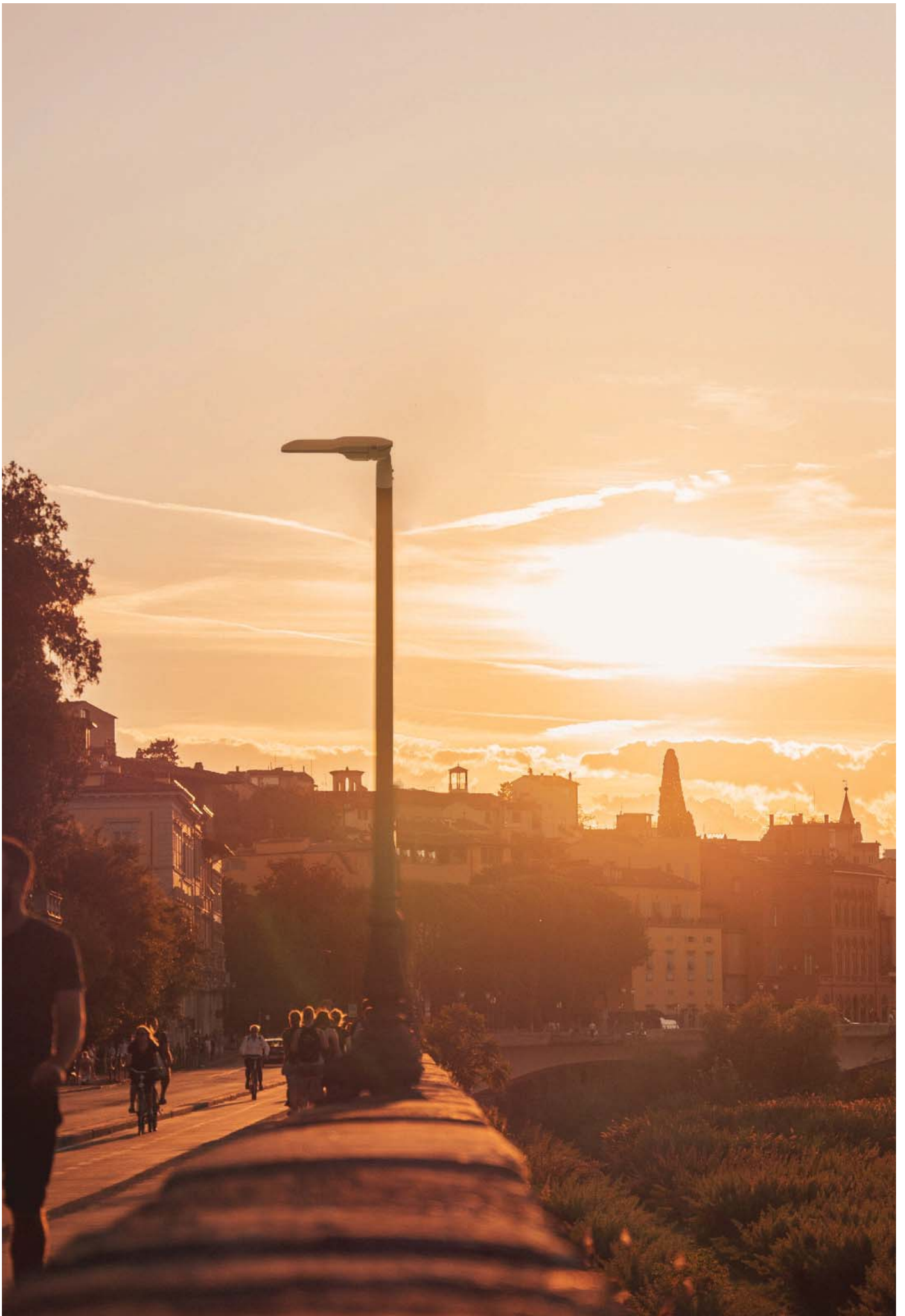

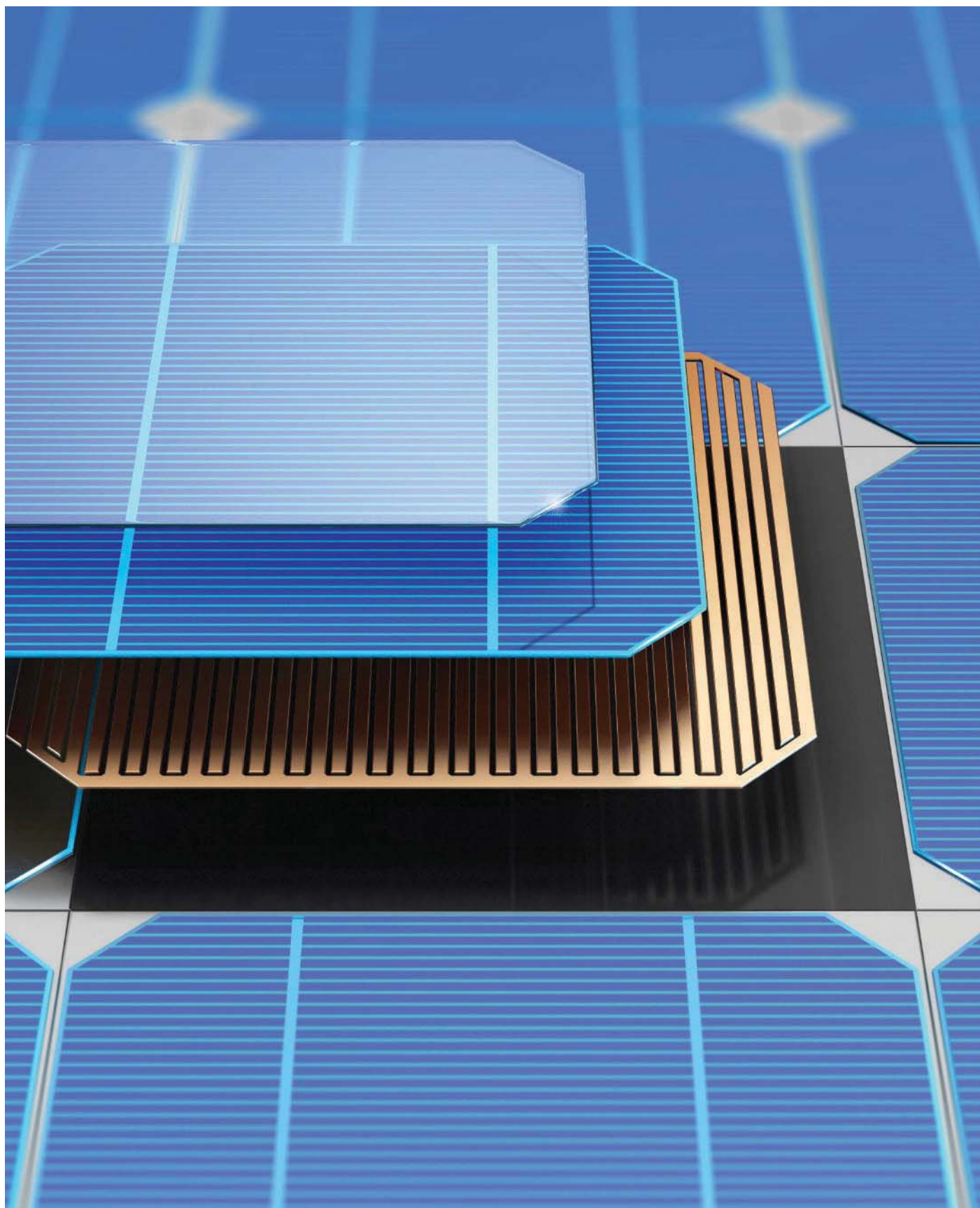

COMPONETES

Componentes Eléctricos

M Driver Philips Certadrive No Flicker

GARANTÍA
5 AÑOS



Ref	Vatios	Acabado	Dimensión	Material	PREZZO IVA escl.
LM2284	44	Blanco	32X108X44H mm	PC	16,50

conf. scat.

1 pz	10 pz	IP20	Potencia max 44W	F.P 0.90	-20°C + 40°C	Salida DC 30-42V	AC 220-240V Max	Int. de corriente 1050mA
------	-------	------	------------------	----------	--------------	------------------	-----------------	--------------------------

Componentes Eléctricos

M Driver Lifud Regulable 0-10V - LF-AAA040B1050-42

GARANTÍA
5 AÑOS



Ref	Vatios	Acabado	Dimensión	Material	PREZZO IVA escl.
LM2520	42	Blanco	141,5X46X27,5H mm	PC	41,90

conf. scat.

1 pz	10 pz	IP20	AC 100-240V max 0.6 A	- 30°C + 50°C	Salida DC 24-40V	F.P 0.90	KV 4	Int.de corriente 550 1050mA
------	-------	------	-----------------------	---------------	------------------	----------	------	-----------------------------

Componentes Eléctricos

M Driver Para Panel de 60X60

GARANTÍA
3 AÑOS



Ref	Vatios	Acabado	PREZZO IVA escl.
LM5316	42	Blanco	7,20

conf. scat.

1 pz	20 pz	IP20	AC 170 265V	Salida DC 24-42V	Int. de corriente 1050mA
------	-------	------	-------------	------------------	--------------------------

Componentes Eléctricos

M Driver para panel LED de 60x60

GARANTÍA
3 AÑOS



Ref	Vatios	Acabado	Dimensión	PREZZO IVA escl.
KB5318	60	Blanco	145X45X3 1H mm	12,10

conf. scat.

1 pz	10 pz	IP20	AC 170 265V	Salida DC 75-100V	Int. de corriente 750mA
------	-------	------	-------------	-------------------	-------------------------

Componentes Eléctricos

M Driver Lifud Regulable 1-10V - LF-GDE030YF

GARANTÍA
5 AÑOS



Ref	Acabado	Dimensión	Material	PREZZO IVA escl.
LF-GDE030YF	Blanco	145X65X30H mm	PC	29,40

conf.	scat.								
1 pz	30 pz	IP20	- 30°C + 50°C	AC 100 277V	Salida DC 27-42V	F.P 0.90	Regulable 1-10V	Int Corriente 600 750mA	Potencia max 30W

Componentes Eléctricos

M Driver Lifud Regulable Triac - LF-GDE030YG No Flicker

GARANTÍA
5 AÑOS



Ref	Acabado	Dimensión	Material	PREZZO IVA escl.
LF-GDE030YG	Blanco	117X46X31 mm	PC	23,90

conf.	scat.								
1 pz	72 pz	IP20	AC 200 240V	- 30°C + 50°C	F.P 0.90	Salida DC 25-40V	Regulable Triac	Int Corriente 550 700mA	Potencia max 20-30W

Componentes Eléctricos

M Driver Lifud Regulable Triac - LF-GDE014YG No Flicker

GARANTÍA
5 AÑOS



Ref	Acabado	Dimensión	Material	PREZZO IVA escl.
LF-GDE014YG	Blanco	97X46X31 mm	PC	16,90

conf.	scat.								
1 pz	90 pz	IP20	AC 200 240V	- 30°C + 50°C	F.P 0.90	Salida DC 25-40V	Regulable Triac	Int Corriente 200 350mA	Potencia max 8-14W

Componentes Eléctricos

M Driver Lifud Regulable Dali - LF-GSD040PF No Flicker

GARANTÍA
5 AÑOS



Ref	Acabado	Dimensión	Material	PREZZO IVA escl.
LF-GSD040PF	Blanco	142X46X28 mm	PC	44,90

conf.	scat.								
1 pz	60 pz	IP20	AC 100 277V	- 30°C + 50°C	F.P 0.90	Salida DC 20-42V	Regulable Dali	Int Corriente 550 1050mA	Potencia max 40W

Componentes Eléctricos

M Driver Lifud Regulable Dali - LF-GSD030PF No Flicker

GARANTÍA
5 AÑOS



Ref	Acabado	Dimensión	Material	PREZZO IVA escl.
LF-GSD030PF	Blanco	142X46X28 mm	PC	41,90

conf. scat.

1 pz	60 pz	IP20	AC 100 277V	- 30°C + 50°C	F.P 0.90	Salida DC 20-42V	Regulable Dali	Int Corriente 400 750mA	Potencia max 32W
------	-------	------	----------------	------------------	-------------	------------------------	-------------------	----------------------------------	------------------------

Componentes Eléctricos

M Driver para panel de 60x60 42W

GARANTÍA
3 AÑOS



Ref	Vatios	Acabado	Material	PREZZO IVA escl.
KB0044	42	Gris	PC	7,10

conf. scat.

1 pz	250 pz	AC 100 277V	Salida DC 126-168V	Int Corriente 350 mAh
------	--------	----------------	--------------------------	-----------------------------

Componentes Eléctricos

M Driver Downlight Panel LED 6W

GARANTÍA
3 AÑOS



Ref	Vatios	Acabado	Material	PREZZO IVA escl.
KB0007	6	Gris	PC	2,10

conf. scat.

1 pz	500 pz	IP20	AC 170 265V
------	--------	------	----------------

Componentes Eléctricos

M Driver Downlight Panel LED 9W

GARANTÍA
3 AÑOS



Ref	Vatios	Acabado	Dimensión	PREZZO IVA escl.
KB0008	9	Gris		2,10

conf. scat.

1 pz	400 pz	IP20	AC 170 265V	Int Corriente 280 mA
------	--------	------	----------------	----------------------------

Componentes Eléctricos

M Driver Downlight Panel LED 12W

GARANTÍA
3 AÑOS



Ref	Vatios	Acabado	Material	PREZZO IVA escl.
KB0009	12	Blanco	PC	2,10

conf.	scat.	IP20	AC 170 265V	Salida DC 24-42V	Int Corriente 280 mA
1 pz	400 pz	IP20	AC 170 265V	Salida DC 24-42V	Int Corriente 280 mA

Componentes Eléctricos

M Driver Downlight Panel LED 20W

GARANTÍA
3 AÑOS



Ref	Vatios	Acabado	Material	PREZZO IVA escl.
KB0010	20	Blanco	PC	2,10

conf.	scat.	IP20	AC 170 265V	Salida DC 36-63V	Int Corriente 280 mA
1 pz	400 pz	IP20	AC 170 265V	Salida DC 36-63V	Int Corriente 280 mA

Componentes Eléctricos

M Driver Downlight Panel LED 25W

GARANTÍA
3 AÑOS



Ref	Vatios	Acabado	Material	PREZZO IVA escl.
KB0011	25	Negro	pc	5,20

conf.	scat.	IP20	AC 170 265V	Salida DC 54-84V	Int Corriente 280 mA
1 pz	200 pz	IP20	AC 170 265V	Salida DC 54-84V	Int Corriente 280 mA

Componentes Eléctricos

M Driver Lifud 40W - LF-GIR040YM1000H

GARANTÍA
5 AÑOS



Ref	Vatios	Acabado	Dimensión	Material	PREZZO IVA escl.
LM2109	40	Blanco	135X36X25H mm	PC	13,90

conf.	scat.	IP20	- 30°C + 50°C	AC 220 240V Max 0.3A	Salida DC 27-42V	Int Corriente 1000 mA	F.P 0.90
1 pz	1 pz	IP20	- 30°C + 50°C	AC 220 240V Max 0.3A	Salida DC 27-42V	Int Corriente 1000 mA	F.P 0.90

Componentes Eléctricos

M Driver Lifud 30W - LF-GIRO030YM750H

GARANTÍA
5 AÑOS



Ref	Vatios	Acabado	Dimensión	Material	PREZZO IVAescl.
LM2108	30	Aluminio	135X36X25H mm	PC	13,80

conf.	scat.							
1 pz	25 pz	IP20	- 30°C + 50°C	AC 220 240V Max 0.3A	Salida DC 27-42V	Int Corriente 750 mA	F.P 0.90	

Componentes Eléctricos

M Driver Lifud Regulable Dali - LF-GDE042YF No Flicker

GARANTÍA
5 AÑOS



Ref	Vatios	Acabado	Dimensión	Material	PREZZO IVAescl.
LM2104	42	Blanco	139X64X30H mm	PC	47,00

conf.	scat.							
1 pz	25 pz	IP20	- 30°C + 50°C	AC 100 240V Max 0.6A	Salida DC 27-42V	Int Corriente 1000 mA	F.P 0.90	Regulable Dali

Componentes Eléctricos

M Kit de Conversion de Emergencia hasta 20W

GARANTÍA
3 AÑOS



Ref	Acabado	Dimensión	Material	PREZZO IVAescl.
LM2128	Blanco	215X40X27H mm	Termoplastico / PC	43,90

conf.	scat.						
1 pz	50 pz	IP30	AC 170 265V	Batería 11.1V 3000mAh	Tiempo carga 24 Hr	Tiempo uso 90 m	

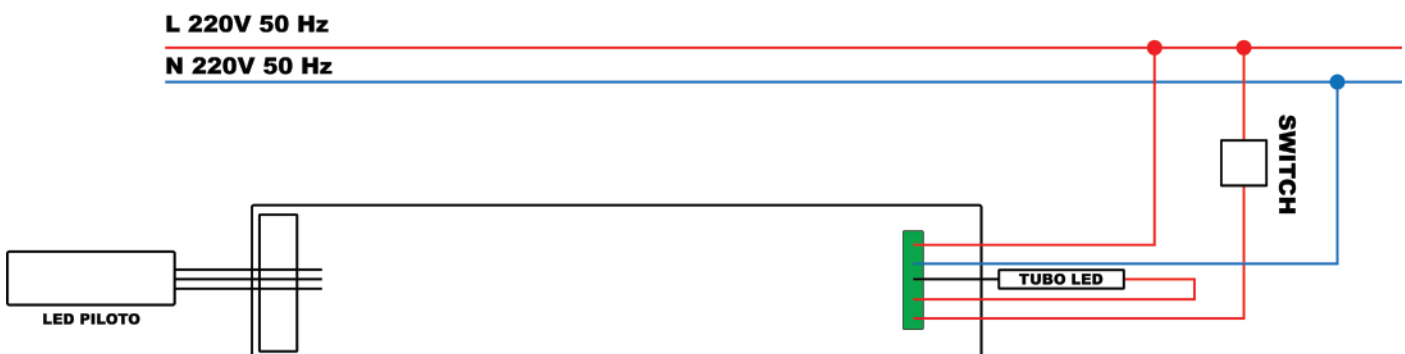



Kit de Conversion de Emergencia hasta 50W - LF-GSP012YG

GARANTÍA 5 AÑOS

Ref	Vatios	Acabado	Dimensión	Material	PREZZO IVA escl.
LF-GSP012YG	6	Rojo	331X91X31H mm	Metal	118,50



conf. scat.

1 pz	12 pz	IP20	AC 100 277V	Salida DC 25-48V	Int Corriente 500 mA	Batería 14.4V 28.8WH	Tiempo carga 24 Hr	Tiempo uso 90 m	F.P 0.95	KV 4
------	-------	------	-------------	------------------	----------------------	----------------------	--------------------	-----------------	----------	------



LF-GSP012YG

Driver de la prestigiosa compañía LIFUD especialmente pensado para situaciones de emergencia en que se precisa que, en caso de fallo de la red eléctrica, satisfaga los requisitos de iluminación en situaciones normales y de emergencia. Para conocer si un driver va a funcionar con nuestra luminaria, PCB o panel deberemos consultar la tensión y la corriente de salida del driver.

Características del Driver Emergencia LIFUD 100-277V No Flicker Salida 25-48V 480mA 12W LF-GSP012YG.

Este Driver Emergencia LIFUD 100-277V No Flicker Salida 25-48V 480mA 12W tiene entrada multi-tensión. Esto significa que es capaz de soportar subidas y bajadas de la tensión de línea durante un corto periodo de tiempo sin sufrir daños. Además, su salida es de 25V-48V DC 2A, y la potencia de salida de emergencia es constante.

Cuando hay un fallo de energía, este Driver de emergencia, cambia al modo de emergencia y proporciona al menos 1,5 horas de iluminación ofreciendo maximo 12W.

Este producto consta de una batería interna de níquel-cadmio resistente a altas temperaturas, un circuito para cargar la batería y un circuito para cambiar a Modo Emergencia que ha sido equipado con protección de cortocircuito de salida, protección de circuito abierto, protección contra bajo voltaje y otras funciones.

La potencia de emergencia se puede seleccionar como 10W o 12W a través del interruptor DIP.

Este Driver LIFUD cuenta con tecnología Flicker-Free, evitando el parpadeo de la luz y por tanto, reduciendo la fatiga ocular.

Despídete de la fatiga ocular, dolores de cabeza y visión borrosa causados por el parpadeo de la luz

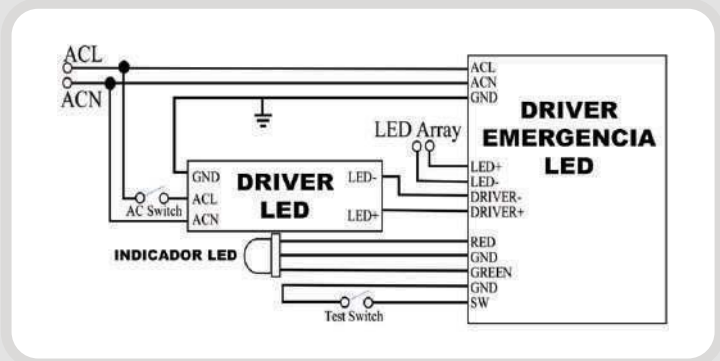
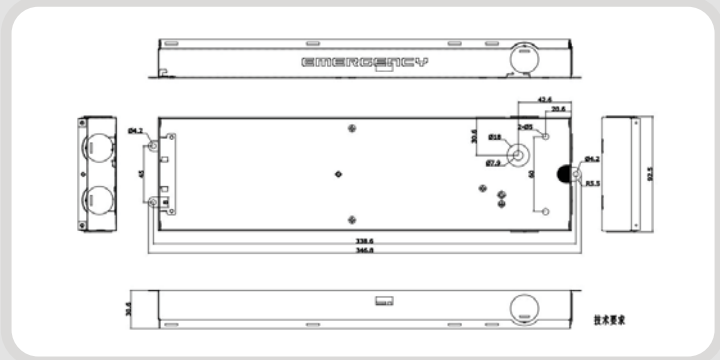



Ref	Acabado	Dimensión	Material	PREZZO IVA escl.
LF-SCD010B	Negro	111X30 mm	PC	32,90

conf.	scat.	IP67	Atenuación entrada Dali/Push	Corriente de entrada ≤ 50 mA	Tensión entrada 11-13Vcc	Atenuación salida 0-10V	Corriente de salida 4 mA	Corriente de fuente salida 25 mA	Conexión 1 hasta 10
1 pz	90 pz								

LF-SCD010B

Nuestro modelo **LF-SCD010B** es un conversor de señal aislado, que transforma la señal DALI / push en una salida de **0-10V**.

Se ajusta al protocolo **DALI IEC 62386-101, 102, 103, 207**. Su tensión de entrada oscila entre 11Vdc y 13Vdc. Un convertidor puede controlar hasta diez controladores LED de **0-10V** con una fuerte señal de salida de 0-10V.

Se adapta con flexibilidad a muchos diseños de sistemas de iluminación **DALI** diferentes.



Componentes Eléctricos

M Conector rápido de 3 entradas hasta 4 mm²

GARANTÍA
3 AÑOS



Ref	Acabado	Dimensión	Material	PREZZO IVA escl.
LM9055	Gris	3,9X1,8X1,4H mm	PC	1,25

conf.	scat.	Int Corriente
2 pz	100 pz	32A

Componentes Eléctricos

M Regleta con clip 3 polos conexión rápida

GARANTÍA
3 AÑOS



Ref	Acabado	Dimensión	Material	PREZZO IVA escl.
LM9020	Blanco	28X20X14H mm	PC	0,50

conf.	scat.	Int Corriente
1 pz	100 pz	5A

Componentes Eléctricos

M Linterna LED Feather Multifunción con Imán



GARANTÍA
3 AÑOS



Ref	Lm	Vatios	Acabado	Dimensión	Material	Temperatura de color	PREZZO IVA escl.
LM9042	160	4	Negro	23X160H mm	ABS	6000 K	6,50

conf.	scat.	Material	Temperatura de color	Pilas AAA no incluidas
1 pz	100 pz	IP20	20000 H	

Componentes Eléctricos

M Linterna LED SurfLED con Gancho e imán IP65 + Función Power Bank



GARANTÍA
3 AÑOS



Ref	Lm	Vatios	Acabado	Dimensión	Material	Temperatura de color	PREZZO IVA escl.
LM9041	500	5	Negro / Amarillo	68X35X110H mm	ABS	6000 K	24,40

conf.	scat.	Material	Temperatura de color	Batería 3.7V 4000mAh
1 pz	50 pz	IP65	20000 H	



Linterna LED SurfLED

Linterna de alta luminosidad, con un potente **LED COB de 5W**, ofreciendo **500 lumens**.

Recargable con cable USB (no incluido), 5 horas de carga ofrecen 6 horas de autonomía.

Batería (Power bank) 3.7V 4000 mAh de muy larga duración que permite también cargar dispositivos USB (smartphones, tablets, etc) con cable mini USB (no incluido)

En la parte posterior incorpora un gancho y un potente imán.



Componentes Eléctricos

M Mando Control para Campana Serie A

GARANTÍA
3 AÑOS



Ref	Dimensión	Material	PREZZO IVA escl.
GA6768	124X51 mm	PC	41,90

conf.	scat.	IP20	AAA 1.5 V DC
1 pz	10 pz		

Componentes Eléctricos

M Sensor de Movimiento Radar IP65 Para Campana Serie A

GARANTÍA
3 AÑOS



Ref	Dimensión	Material	PREZZO IVA escl.
GA6767	60X53 mm	PC	35,90

conf.	scat.	IP65	DC 10 15V	Ángulo 360°	Detección 15 m	Regulable
1 pz	10 pz					

Componentes Eléctricos

M Regulador LED 0-10V

GARANTÍA
3 AÑOS



Ref	Vatios	Acabado	Dimensión	Material	PREZZO IVA escl.
LM9102	250	Blanco	87X87X54H mm	PC	25,50

conf.	scat.	IP20	AC 220 240V	Empotrable Superficie
1 pz	5 pz			

Componentes Eléctricos

M Kit Aro / Anillo de Luz LED Selfie



GARANTÍA
3 AÑOS



Ref	Vatios	Pulgadas	Acabado	Dimensión	Material	Temperatura de color	PREZZO IVA escl.
LM9061	12	10	Negro	260X30 mm	ABS	CCT	27,90
LM9062	13	12	Negro	300X30 mm	ABS	CCT	36,70
LM9063	20	14	Negro	355X30 mm	ABS	CCT	56,40

Accesorios



Soporte
LM9064

conf.	scat.	IP20	5V DC	120°
1 pz	5 pz			

Componentes Eléctricos

M Aplique LED World con sensor de movimiento



GARANTÍA
3 AÑOS



Ref	Lm	Vatios	Acabado	Dimensión	Material	Temperatura de color	PREZZO IVA escl.
LM9004	210	3	Blanco	80X80X20H mm	PC	6000 K	7,96

conf. scat.

1 pz	10 pz	IP20	25000 H	DC 5V
------	-------	------	---------	-------

Componentes Eléctricos

M Aplique LED Hearth con sensor de movimiento



GARANTÍA
3 AÑOS



Ref	Lm	Vatios	Acabado	Dimensión	Material	Temperatura de color	PREZZO IVA escl.
LM4232	210	3	Blanco	38X120X17H mm	PC	6000 K	16,20

conf. scat.

1 pz	10 pz	IP20	25000 H	DC 5V
------	-------	------	---------	-------

Componentes Eléctricos

M Bisalight LED para Bisagra

GARANTÍA
3 AÑOS



Ref	Lm	Vatios	Acabado	Dimensión	Material	PREZZO IVA escl.
LM4234	200	0,5	Gris	70X40X20H mm	ABS	2,10

conf. scat.

1 pz	10 pz	IP20	120°	1 pila 23A
------	-------	------	------	------------

Componentes Eléctricos

M Extractor Ofair 60X60 cm

GARANTÍA
3 AÑOS



Ref	Vatios	Acabado	Dimensión	Material	PREZZO IVA escl.
LM9019	50	Blanco	595X595X140,5H mm	PC	114,90

conf. scat.

1 pz	5 pz	IP44	AC 170 265V	Corte 98 mm	Caudal 650m3/Hr	28 Db	Diametro salida 100 mm
------	------	------	-------------	-------------	-----------------	-------	------------------------

Componentes Eléctricos

M Extractor Hadary 15W

GARANTÍA
3 AÑOS



Ref	Vatios	Acabado	Dimensión	Material	PREZZO IVA escl.
LM9018	15	Blanco	152X152X105H mm	PC	24,40

conf.	scat.	IP44	AC 170 265V	Corte 98 mm	Caudal 180m3/Hr	20 Db
1 pz	10 pz					

Componentes Eléctricos

M Protector Sobretensiones 10Kv SOSEN



GARANTÍA
3 AÑOS



Ref	Acabado	Dimensión	Material	PREZZO IVA escl.
LM9029	Blanco	75X35X28H mm	PC	19,90

conf.	scat.	IP20	DC 100 380V	KV 6
1 pz	125 pz			

Componentes Eléctricos

M Control Remoto - App Smart Life



GARANTÍA
3 AÑOS



Ref	Acabado	Dimensión	Material	PREZZO IVA escl.
LM9009	Blanco	85X85X14H mm	PC	84,90

conf.	scat.
1 pz	5 pz

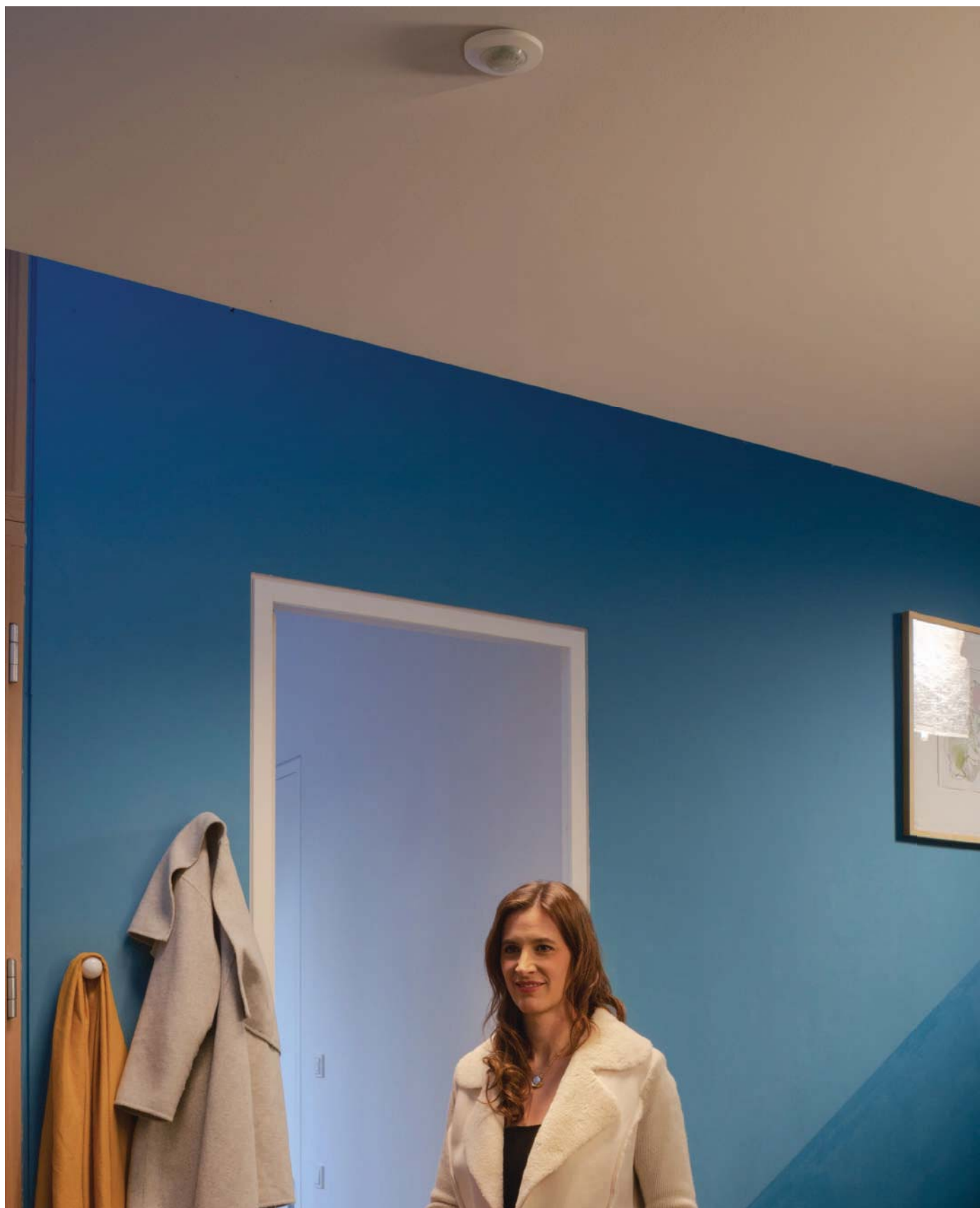

DETECTORES

Detectores de Presencia

M Detector de movimiento PIR 180° Superficie

GARANTÍA
3 AÑOS



Ref	Acabado	Dimensión	Material	PREZZO IVA escl.
LM8275	Blanco	100X95 mm	PC Ignifugo	14,80
LM8276	Negro	100X95 mm	PC Ignifugo	14,80

conf. scat.

1 pz	25 pz	IP44	30000 H	AC 220 240V	Potencia max 1200	Detección 12 m	Regulación Día / Noche	Ángulo 180°	Tiempo min-max 10 seg 7 min
------	-------	------	---------	-------------	-------------------	----------------	------------------------	-------------	-----------------------------

Detectores de Presencia

M Detector de movimiento PIR 180° Superficie

GARANTÍA
3 AÑOS



Ref	Acabado	Dimensión	Material	PREZZO IVA escl.
LM8277	Blanco	130X120 mm	PC Ignifugo	16,60
LM8278	Negro	130X120 mm	PC Ignifugo	16,60

conf. scat.

1 pz	25 pz	IP44	30000 H	AC 220 240V	Potencia max 1200	Detección 12 m	Regulación Día / Noche	Ángulo 180°	Tiempo min-max 10 seg 7 min
------	-------	------	---------	-------------	-------------------	----------------	------------------------	-------------	-----------------------------

Detectores de Presencia

M Detector de Movimiento PIR Mini 360° Superficie

GARANTÍA
3 AÑOS



Ref	Vatios	Acabado	Dimensión	Material	PREZZO IVA escl.
LM9011	25	Blanco	75X20H mm	PC	12,50

conf. scat.

1 pz	100 pz	IP20	30000 H	AC 220 240V	Potencia max 100	Detección 6 m	Regulación Día / Noche	Ángulo 360°	Tiempo min-max 10 seg 2 min
------	--------	------	---------	-------------	------------------	---------------	------------------------	-------------	-----------------------------

Detectores de Presencia

M Detector de Movimiento Infrarrojo 360° Superficie

GARANTÍA
3 AÑOS



Ref	Acabado	Dimensión	Material	PREZZO IVA escl.
LM9015	Blanco	115X55H mm	PC Ignifugo	16,70

conf. scat.

1 pz	50 pz	IP20	30000 H	AC 220 240V	Potencia max 300	Detección 6 m	Regulación Día / Noche	Tiempo min-max 10 seg 2 min	Ángulo 360°
------	-------	------	---------	-------------	------------------	---------------	------------------------	-----------------------------	-------------

Detectores de Presencia

M Detector de Movimiento PIR Square 160°

GARANTÍA
3 AÑOS



Ref	Acabado	Dimensión	Material	PREZZO IVA escl.
LM9012	Blanco	75X20H mm	PC Ignifugo	17,80

conf. scat.

1 pz	25 pz	IP20	30000 H	AC 220 240V	Potencia max 300	Detección 9 m	Regulación Día / Noche	Tiempo min-max 10 seg 2 min	Ángulo 160°
------	-------	------	---------	----------------	------------------------	------------------	---------------------------	--------------------------------------	----------------

Detectores de Presencia

M Detector de Movimiento PIR 180° Superficie

GARANTÍA
3 AÑOS



Ref	Acabado	Dimensión	Material	PREZZO IVA escl.
LM9013	Blanco	86.5X60X97.5H mm	PC Ignifugo	15,30

conf. scat.

1 pz	50 pz	IP20	30000 H	AC 220 240V	Potencia max 300	Detección 12 m	Regulación Día / Noche	Tiempo min-max 10 seg 2 min	Ángulo 160°
------	-------	------	---------	----------------	------------------------	-------------------	---------------------------	--------------------------------------	----------------

Detectores de Presencia

M Detector de movimiento Mini PIR 360° Empotrable

GARANTÍA
3 AÑOS



Ref	Acabado	Dimensión	Material	PREZZO IVA escl.
LM9014	Blanco	22X26H mm	PC Ignifugo	16,40

conf. scat.

1 pz	20 pz	IP20	30000 H	AC 220 240V	Potencia max 100	Detección 6 m	Regulación Día / Noche	Tiempo min-max 10 seg 2 min	Ángulo 360°
------	-------	------	---------	----------------	------------------------	------------------	---------------------------	--------------------------------------	----------------

Detectores de Presencia

M Detector de movimiento PIR 360° Empotrable

GARANTÍA
3 AÑOS



Ref	Acabado	Dimensión	Material	PREZZO IVA escl.
LM9016	Blanco	74X80H mm	PC Ignifugo	17,00

conf. scat.

1 pz	50 pz	IP20	30000 H	AC 220 240V	Potencia max 300	Detección 6 m	Regulación Día / Noche	Tiempo min-max 10 seg 2 min	Corte 60 mm	Ángulo 360°
------	-------	------	---------	----------------	------------------------	------------------	---------------------------	--------------------------------------	----------------	----------------



Detectores de Presencia

Detector de movimiento PIR 360° Empotrable Silver

GARANTÍA
3 AÑOS



Ref	Acabado	Dimensión	Material	PREZZO IVA escl.
LM9017	Blanco / Gris	50X65H mm	PC Ignifugo	18,60

conf. scat.

1 pz	50 pz	IP20	30000 H	AC 220 240V	Potencia max 300	Detección 6 m	Regulación Día / Noche	Tiempo min-max 10 seg 2 min	Corte 60 mm	Ángulo 360°
------	-------	------	---------	----------------	------------------------	------------------	---------------------------	--------------------------------------	----------------	----------------



REGULACIÓN DE TIEMPO

Posibilidad de regular el tiempo max - min, con esta función puede decidir el tiempo máximo (2 o 7 minutos) y el mínimo 10 segundos.



REGULACIÓN DE SENSIBILIDAD

Posibilidad de regular la sensibilidad a la luz solar, con esta función puede determinar el nivel de falta de luz solar a la que desea que el detector se active.

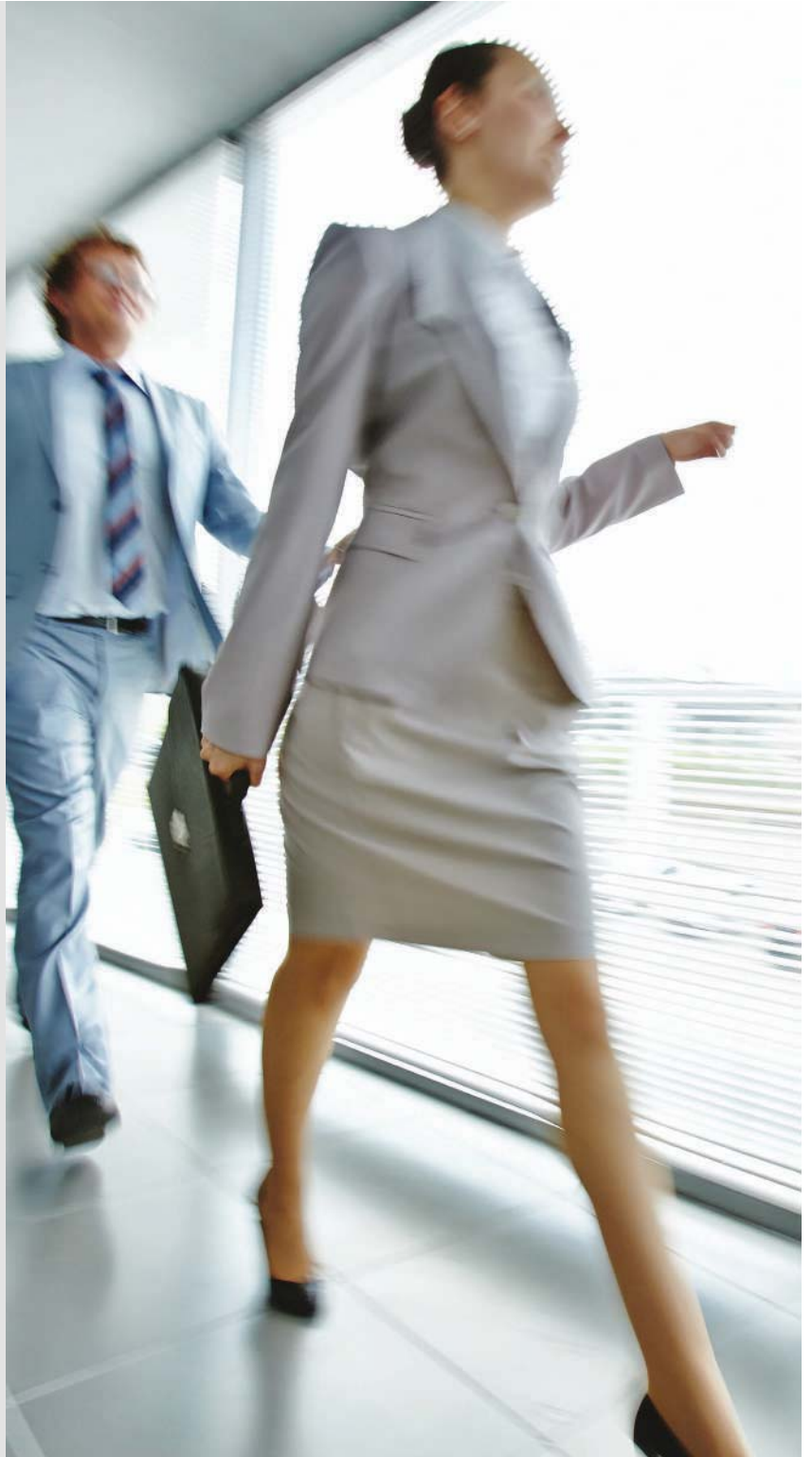



AROS Y ACCESORIOS

Aros y Accesorios

M Chapa adaptación para farol Villa

GARANTÍA
3 AÑOS



Ref	Corte	Acabado	Dimensión	Material	PREZZO IVA escl.
LM6444	1 modulo	Blanco	325X325 mm	Aluminio	10,90
LM6445	2 modulos	Blanco	325X325 mm	Aluminio	10,90

conf. scat.

1 pz

5 pz

Aros y Accesorios

M Cinta adhesiva 3M de doble cara 50 metros

GARANTÍA
3 AÑOS



Ref	MM	Dimensión	PREZZO IVA escl.
LM2071	8 mm	8X50000 mm	10,60
LM2072	10 mm	10X50000 mm	12,90

conf. scat.

1 pz

1 pz

Aros y Accesorios

M Aro Cardan Aras Para Modulo Arumled / GU10 / MR16

GARANTÍA
3 AÑOS

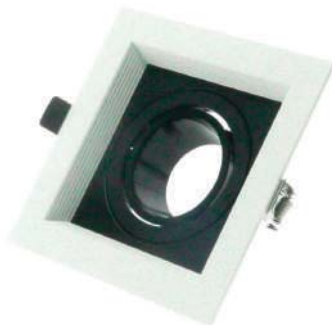

Ref	Acabado	Dimensión	Dimensión de Corte	Material	PREZZO IVA escl.
LM4379	Blanco y Negro	120X120X40H mm	90X90 mm	Aluminio	15,90

conf. scat.

1 pz

10 pz

Aros y Accesorios

M Aro Cardan Aras Doble Para Modulo Arumled / GU10 / MR16

GARANTÍA
3 AÑOS



Ref	Acabado	Dimensión	Dimensión de Corte	Material	PREZZO IVA escl.
LM4380	Blanco y Negro	225X120X40H mm	195X90 mm	Aluminio	24,90

conf. scat.

1 pz

10 pz

Aros y Accesorios

M Aro Fijo Redondo Blanco Serie Infinity Para Gu10 / MR16

GARANTÍA
3 AÑOS



Ref	Acabado	Dimensión	Dimensión de Corte	Material	PREZZO IVAescl.
LM4338	Blanco	83X35H mm	67 mm	Aluminio	6,90

conf.	scat.
1 pz	50 pz

Aros y Accesorios

M Aro Basculante Redondo Negro Serie Evo Para Gu10 / MR16

GARANTÍA
3 AÑOS



Ref	Acabado	Dimensión	Dimensión de Corte	Material	PREZZO IVAescl.
LM4326	Negro	93X40H mm	82 mm	Aluminio	8,40

conf.	scat.
1 pz	100 pz

Aros y Accesorios

M Aro Basculante Redondo Blanco Serie Evo Para Gu10 / MR16

GARANTÍA
3 AÑOS



Ref	Acabado	Dimensión	Dimensión de Corte	Material	PREZZO IVAescl.
LM4325	Blanco	93X40H mm	82 mm	Aluminio	8,40

conf.	scat.
1 pz	100 pz

Aros y Accesorios

M Aro basculante redondo blanco Serie Luxury Para GU10 / MR16

GARANTÍA
3 AÑOS



Ref	Acabado	Dimensión	Dimensión Corte	Material	PREZZO IVAescl.
LM4322	Blanco	85 mm	65 mm	Aluminio	4,65

conf.	scat.
1 pz	100 pz

Aros y Accesorios

M Aro basculante redondo níquel Serie Luxury Para GU10 / MR16

GARANTÍA
3 AÑOS



Ref	Acabado	Dimensión	Dimensión Corte	Material	PREZZO IVA escl.
LM4321	Níquel	85 mm	65 mm	Aluminio	4,65

conf.	scat.
1 pz	100 pz

Aros y Accesorios

M Aro basculante cuadrado blanco Serie Luxury Para GU10 / MR16

GARANTÍA
3 AÑOS



Ref	Acabado	Dimensión	Dimensión Corte	Material	PREZZO IVA escl.
LM4324	Blanco	90X90 mm	65 mm	Aluminio	5,20

conf.	scat.
1 pz	100 pz

Aros y Accesorios

M Aro basculante cuadrado níquel Serie Luxury Para GU10 / MR16

GARANTÍA
3 AÑOS



Ref	Acabado	Dimensión	Dimensión Corte	Material	PREZZO IVA escl.
LM4323	Níquel	90X90 mm	65 mm	Aluminio	7,90

conf.	scat.
1 pz	100 pz

Aros y Accesorios

M Aro basculante redondo blanco Serie Eco Para GU10 / MR16

GARANTÍA
3 AÑOS



Ref	Acabado	Dimensión	Dimensión Corte	Material	PREZZO IVA escl.
LM4318	Blanco	85 mm	70 mm	Aluminio	3,00

conf.	scat.
1 pz	200 pz

Aros y Accesorios

M Aro basculante redondo níquel Serie Eco Para GU10 / MR16

GARANTÍA
3 AÑOS



Ref	Acabado	Dimensión	Dimensión Corte	Material	PREZZO IVAescl.
LM4317	Níquel	85 mm	70 mm	Aluminio	3,00

conf.	scat.
1 pz	200 pz

Aros y Accesorios

M Aro basculante cuadrado níquel Serie Eco Para GU10 / MR16

GARANTÍA
3 AÑOS



Ref	Acabado	Dimensión	Dimensión Corte	Material	PREZZO IVAescl.
LM4319	Níquel	85X85 mm	70 mm	Aluminio	6,30

conf.	scat.
1 pz	100 pz

Aros y Accesorios

M Aro basculante cuadrado blanco Serie Eco Para GU10 / MR16

GARANTÍA
3 AÑOS



Ref	Acabado	Dimensión	Dimensión Corte	Material	PREZZO IVAescl.
LM4320	Blanco	85X85 mm	70 mm	Aluminio	3,15

conf.	scat.
1 pz	100 pz

Iluminación Interior / Plafones LED

M Aplique de Techo Berlín Gu10



GARANTÍA
3 AÑOS



Ref	Acabado	Dimensión	Material	PREZZO IVAescl.
LM4271	Blanco	111X155H mm	Aluminio	14,40

conf.	scat.	Potencia max
1 pz	10 pz	40W

Iluminación Interior / Plafones LED

M Aplique de Techo Milano Gu10



GARANTÍA
3 AÑOS



Ref	Acabado	Dimensión	Material	PREZZO IVA escl.
LM4272	Blanco	98X118H mm	Aluminio	10,80

conf.	scat.	IP20	Potencia max 40W
1 pz	10 pz		

Aros y Accesorios

M Soporte de pared para Farolas Led

GARANTÍA
3 AÑOS



Ref	Acabado	Dimensión	Diametro de fijación	Material	PREZZO IVA escl.
LM6657	Gris	500X150X73H mm	60 mm	Hierro	17,80
LM6657A	Gris	500X150X73H mm	45 mm	Hierro	17,10

conf.	scat.
1 pz	20 pz

Aros y Accesorios

M Brazo articulado para Foco Infinity 180°

GARANTÍA
3 AÑOS



Ref	Acabado	Dimensión	Material	PREZZO IVA escl.
LM6652	Gris	160X72 mm	Aluminio	21,30

conf.	scat.
1 pz	20 pz

Aros y Accesorios

M Soporte para proyectores LED 730 mm

GARANTÍA
3 AÑOS



Ref	Acabado	Dimensión	Material	PREZZO IVA escl.
LM6653	Negro	360X150X83H mm	Hierro	14,90
LM6654	Negro	530X155X75H mm	Hierro	17,00
LM6656	Negro	720X155X75H mm	Hierro	22,50

conf.	scat.
1 pz	10 pz

Aros y Accesorios > Alumbrado Público

M Brazo articulado para Farola 180°

GARANTÍA
3 AÑOS



Ref	Acabado	Dimensión	Diametro de fijación	Material	PREZZO IVAescl.
LM6255	Gris	240X80X80 mm	60 mm	Aluminio	33,90

conf.	scat.
1 pz	16 pz

Aros y Accesorios

M Conector en I IP68

GARANTÍA
3 AÑOS



Ref	Acabado	Dimensión	Material	PREZZO IVAescl.
LM2191	Negro	50X35X22H mm	PC	6,90

conf.	scat.
50 pz	200 pz
	IP 68

Aros y Accesorios

M Conector en Y IP68

GARANTÍA
3 AÑOS



Ref	Acabado	Dimensión	Material	PREZZO IVAescl.
LM2193	Negro	75X35X140H mm	PC	11,60

conf.	scat.
1 pz	50 pz
	IP 68

Aros y Accesorios

M Conector en T IP68

GARANTÍA
3 AÑOS



Ref	Acabado	Dimensión	Material	PREZZO IVAescl.
LM2192	Negro	90X35X95H mm	PC	11,70

conf.	scat.
1 pz	50 pz
	IP68

Aros y Accesorios

M Caja con Cinco Conectores IP68

GARANTÍA
3 AÑOS



Ref	Acabado	Dimensión	Material	PREZZO IVA escl.
LM2194	Negro	130 X 105 X 37H mm	PC	12,80

conf.

100 pz

IP

68

Aros y Accesorios

M Guirnalda de 10 casquillos E27 Exterior IP65 cable eléctrico

GARANTÍA
3 AÑOS



Ref	Acabado	Dimensión	Material	PREZZO IVA escl.
LM8956	Negro	5000 mm	PC	26,50

conf.

1 pz

scat.

15 pz

IP

65

Aros y Accesorios

M Adaptador E27 a E40

GARANTÍA
3 AÑOS



Ref	Dimensión	Material	PREZZO IVA escl.
LM9023	386X44H mm	Aluminio	1,99

conf.

10 pz

scat.

100 pz

Aros y Accesorios

M Adaptador E27 a E40 Cerámico

GARANTÍA
3 AÑOS



Ref	Dimensión	Material	PREZZO IVA escl.
LM9022	39X44H mm	Ceramica	2,55

conf.

10 pz

scat.

100 pz

Aros y Accesorios

M Cable alargador de 2 metros solo compatible con focos solares Venecia

GARANTÍA
3 AÑOS



Ref	Acabado	Dimensión	Material	PREZZO IVA escl.
KB1903	Negro	2000 mm	Aluminio	7,90

conf.	scat.
1 pz	10 pz

Iluminación Interior / Aros y Accesorios / Paneles LED

M Grapas para paneles LED

GARANTÍA
3 AÑOS



Ref	Acabado	Dimensión	Material	PREZZO IVA escl.
LM9033	Metal	50X25X12H mm	Aluminio	3,30

conf.	scat.
1 pz	20 pz

Iluminación Interior / Aros y Accesorios / Paneles LED

M Colgadores para paneles LED

GARANTÍA
3 AÑOS



Ref	Acabado	Dimensión	Material	PREZZO IVA escl.
LM9031	Metal	3000 mm	Aluminio	7,00

conf.	scat.
1 pz	100 pz

Aros y Accesorios / Focos de Carril LED / Focos de Carril Led Trifásicos / Focos de Carril Led Monofásicos / Focos de Carril LED Bifásicos

M Colgadores Para Carril Led

GARANTÍA
3 AÑOS



Ref	Acabado	Dimensión	Material	PREZZO IVA escl.
LM3263	Metal	1500 mm	Aluminio	9,90

conf.	scat.
1 pz	200 pz



Sede Legale: Via Carmine Calò 5 – 84022 Campagna (SA) Italy
P.Iva / C.F. 05288100653 - REA: SA434748 - Tel. +39 0828 504505

email: info@hydradigital.it – web: www.hydradigital.it